

VERSION 11



DECK HARDWARE



 **SELDÉN**
for sailing

PRODUCT CATALOGUES

The Seldén Deck hardware product catalogue will be helpful for you finding all the deck hardware you need for enjoyable sail handling. This is just one of five product catalogues covering our extensive range of Yacht, Keelboat, Dinghy, Carbon and Deck Hardware products. If you need any of the other catalogues you are welcome to pick them up from your local dealer or to download from www.seldenmast.com.

YACHT

Rig systems and accessories for 25 to 80 ft boats.



Art. No. 595-808-E

KEELBOAT

Rig systems and accessories for 18 to 26 ft boats.



Art. No. 595-950-E

DINGHY

Rig systems and accessories for dinghies.

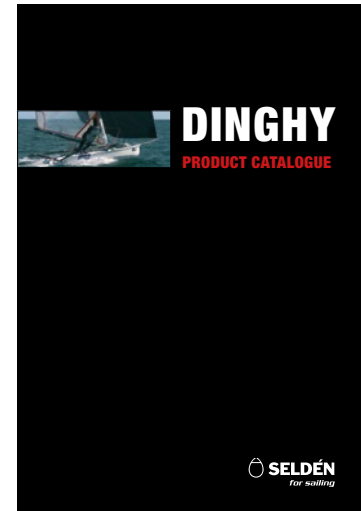

Art. No. 595-812-E

CARBON

Carbon rig systems.

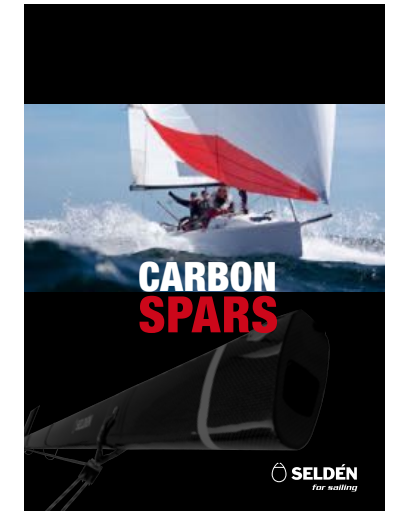

Art. No. 595-823-E

SELDÉN DECK HARDWARE CATALOGUE, VERSION 11

Check out the following pages for new products. **New products in orange.**

Página

- 69 System 30 Performance
- 71 System 42
- 97 Mainly for dinghies

Página

- 14 PBB 20
- 19 PBB 60
- 37 BBB 30
- 39 BBB 40

ALWAYS ON **THE RIGHT TRACK**



Making the best rig systems in the world is more than a job at Seldén. It's a passion. Every Seldén rig is designed and carefully dimensioned for the particular boat. In our search for perfection, no detail is considered too small. Setting our own deck hardware standards is a natural step in this systematic approach to achieving the best possible product for the given task. No matter the size of your boat, whether you push your equipment to the very limit, or just enjoy leisurely cruising; when you go Seldén, you'll go first class, all the way.

Photo credit:

Nico Krauss Front page, Dan Ljungsvik 5, 8 (upper), 12, 13, 15, 16, 18, 20, 21, 22, 26 (upper), 32 (lower), 34, 40, 42 (upper), 44, 48, 50 (lower), 51, 57, 58, 74, 78, 81,84 (upper), 86 (lower), 88, 90 (lower), 92, 99 Leif Wiklund & Dan Ljungsvik studio photos, Ola Stensby/Niklas Strandberg 10, Joakim Hermansson 14, Jonna Hautau 23, 54, Peter Szamer 24, Peter Gustafsson 26 (lower), 28 (upper), 30, 50 (upper), 64 (upper), 68, 82, 90 (upper), Jonas Granhed 27, 28 (lower), 56, 60, 62, 65, 93, John Patience 32 (upper), Carol Baker 36, RS Sailing, 46 (upper), Roberto Vuilleumier 46 (lower), Mats-Uno Fredrikson 48, 49, Performance Sailcraft Europe 52 (lower), Arthur Smeets,70, Tommy Andersson 76, Tjelvar Eriksson 95, 99, Rick Tomlinson 86 (upper), Christer Bernson 96.

The information and specifications contained in this catalogue are subject to change without prior notice.

WITH PASSION. ALL THE WAY FROM THE DRAWING BOARD.



Sailing is an immersive experience. The combination of wind and waves provides an ever-changing environment that a sailor must react to. It is vital that the equipment required to respond to these demands enables fast, precise and easy handling of the sails to allow the sailor to meet these dynamic challenges.

With well-chosen equipment that is reliable, functional and elegant in design, this demanding experience is quickly reduced to allow the

simplistic pleasure of the interaction between the sailor and the elements.

Since 1960, Seldén has worked tirelessly to ensure the extensive experience and passion for sailing is engrained in every design and component that goes to make the masts, standing and running rigging that has led Seldén to be the world's leading rig system manufacturer. The Seldén Deck hardware range continues this ethos and has been created to provide the

perfect combination of reliability, functionality and elegance that allows sailors to focus on sail handling and tuning. Developed through work with boats yards, sailmakers and yacht designers worldwide, the designs have encapsulated Seldén's drive to produce a product for any situation.

It reflects our passion, all the way from the drawing board.



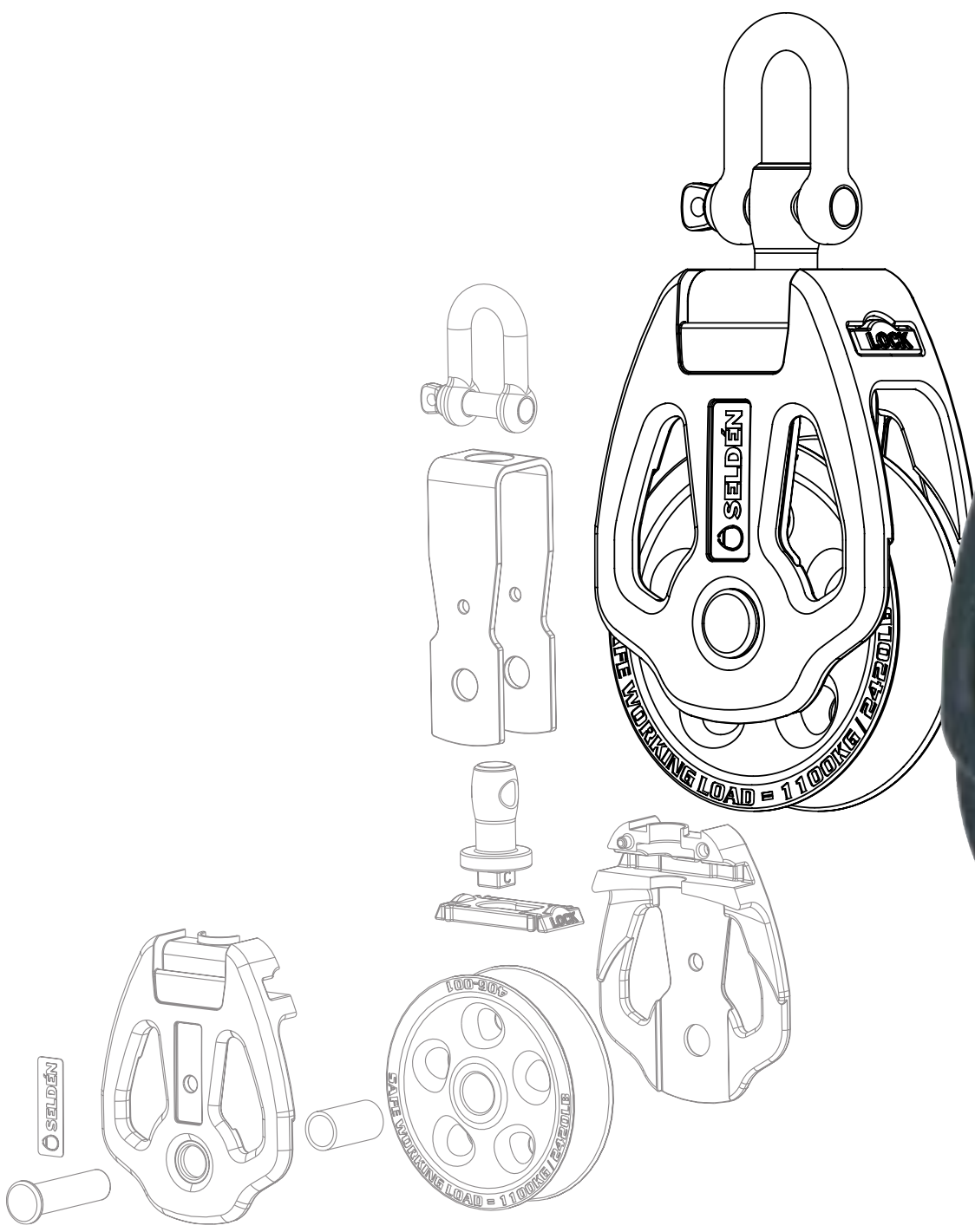

CHOOSE THE RIGHT PRODUCT

BREAKING LOADS AND SAFE WORKING LOADS

Breaking loads

Our definition of a breaking load is that load which causes any part of a product to break when it is subjected to successively increasing loads during laboratory testing.

Safe working loads

Our definition of safe working load is set at half the breaking load. We guarantee that products subjected to loads that are below or up to this limit will function satisfactorily.

Loads in the specification tables

The breaking load and safe working load values shown in the product tables are for the product itself (not for the line). The load exerted on the product depends on the load in the line and on the deflection angle of the lines around the sheave. For more information see page 100.

Purchase systems

A mechanical system can be used to increase the effect of human force required for a specific situation. Such systems are designed in several ways. A selection of typical mechanical systems are shown to the right.

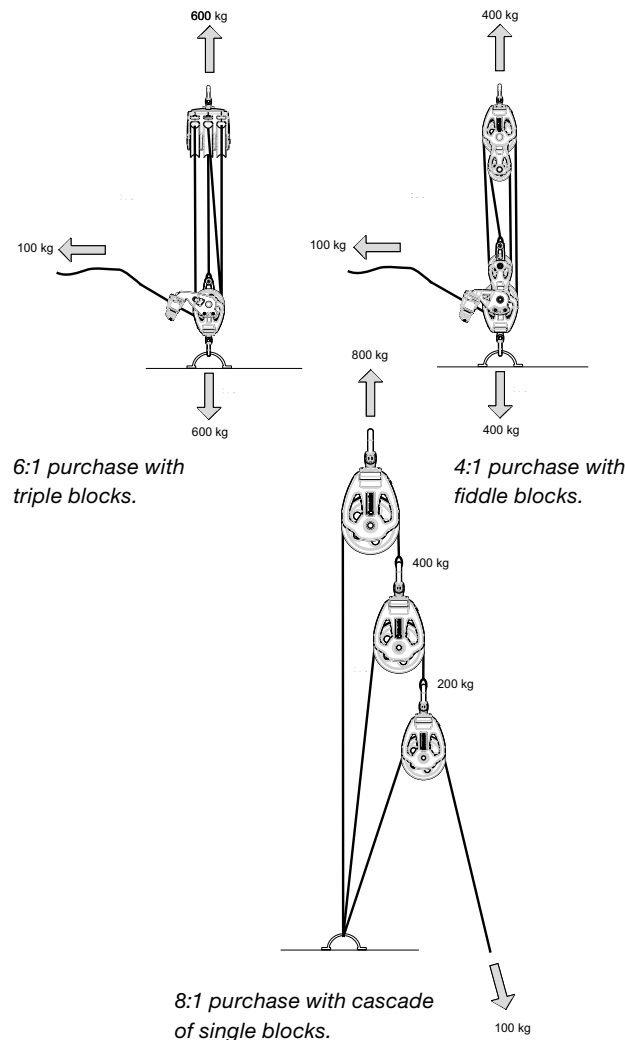

LOW LOADS AND HIGH LOADS

The practical difference between high loads and low loads depends on the amount of force you must exert to handle them. In our definition, we set the dividing line between high loads and low loads at 100 kg. Even when the load is less than 100 kg, a normal person will require a mechanical system to deal with it, although the mechanical advantage may be relatively low.

A block and tackle with, say, a mechanical advantage of 4:1 converts a load of 100 kg into 25 kg, which can, of course, be easily managed by a single crew member. Using a block and tackle with a mechanical advantage of 4:1 means that four times the length of line must be pulled. In theory, this will take longer than it would take without any mechanical advantage.

The choice of mechanical advantage depends, therefore, on the load you feel able to manage and how quickly you want to do the job.

STATIC APPLICATION

A static application is one that does not cause the block sheave to spin. A typical static application is a halyard turning block, where the sheave remains still under load for long periods of time.

DYNAMIC APPLICATION

A dynamic application is one that causes the block sheave to spin. A typical dynamic application is a main sheet tackle, where the sheaves spin frequently when sailing.

SELDÉN DESIGNATIONS

All Seldén's Deck hardware products have been given descriptive names. See below for the blocks designations.

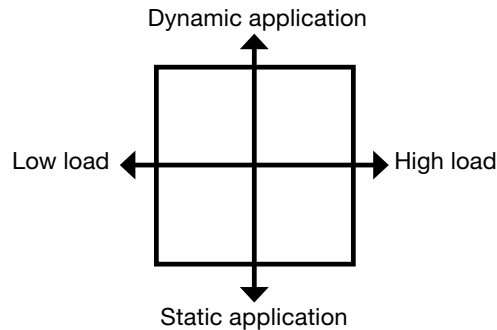

All Seldén blocks are of the same superb quality and are the best for their particular application. In order to make it easy to select the right block for your application, we have categorised them to suit low loads, high loads, static applications and dynamic applications.

SYSTEM 15

Dinghy 22'

SYSTEM 22

20' 33'

SYSTEM 30

30' 45'

SYSTEM 42

40' 65'

Tracks and travellers are available in four sizes 15, 22, 30 and 42. This simplified model provides an indication about which system that can be used for which boatsize.

Seldén blocks are designated in accordance with two main features of the block. The first part of the designation specifies the type of bearing system or other special feature. The second part of the designation tells you the sheave diameter. For example, the **PBB 60** is a **Plain Bearing Block** with a sheave diameter of **60** mm.

THE BLOCK FAMILIES

The blocks are divided into families. All the blocks in a specific family have the same sheave. The part numbers of the sheaves are the basis of the part numbers of the blocks. For example, the PBB 60 sheave is designated 406-001 and the PBB 60 single block is designated 406-001-01.

The part numbers of the sheaves are stamped on the side of each sheave.

For more information about how to dimension the Seldén Deck hardware products, see page 102.



SELDÉN DECK HARD- WARE



The Seldén deck hardware range is carefully designed, developed and manufactured under the strict quality control and attention to detail that is the hallmark of Seldén. All Seldén deck hardware is supplied with a 2-year warranty.

BLOCKS



Plain bearing blocks,
page 12



Ball bearing
blocks,
page 32



Roller bearing
blocks,
page 28



High load ball
bearing blocks,
page 46

CLEATS & SWIVELS



Cam cleats
page 86



Valley cleats,
page 88



Eye swivel,
page 90



Deck swivel,
page 91



Ratchet blocks,
page 42



High load plain
bearing blocks,
page 48

TRACKS & TRAVELLERS



System 15,
page 52



Tracks,
page 54



System 22,
page 60



System 30,
page 62



System 30 Performance,
page 66



System 42,
page 70



Self tacking system,
page 78



Tackles,
page 83



Mast swivel,
page 91

DECK ORGANIZERS



Deck organizers,
page 92

COMPLEMENTARY DECK HARDWARE



Accessories,
page 94

DIMENSIONING

Loads,
page 100

Dimensioning,
page 102

Unsupported
tracks,
page 106

Hole patterns,
page 107



BLOCKS MADE FOR PERFECT INTERACTION

Seldén blocks give you the benefits of a high strength to weight ratio. We only use top quality materials like glass fibre reinforced polymer and marine grade stainless steel. Each component is designed for top performance and perfect interaction with the rig under all conditions. The Seldén block range consists of plain bearing blocks, roller bearing blocks, ball bearing blocks, high load ball bearing blocks, high load plain bearing blocks and ratchet blocks.



Plain bearing blocks



Roller bearing blocks



Ball bearing blocks



High load ball bearing blocks



High load plain bearing blocks



Ratchet blocks



PLAIN BEARING BLOCKS

TECHNICAL FEATURES

- Stainless steel strap for strength and long service life (PBB 50-PBB 80).
- Torsional rigid cheeks in glass fibre reinforced polymer to prevent jamming (PBB 40-PBB 80).
- Tool-free swivel locking mechanism (PBB 50-PBB 80).

TYPICAL APPLICATIONS

- Boom vang
- Tackles
- Halyard blocks
- Spinnaker sheet and guys
- Preventers
- Cascades

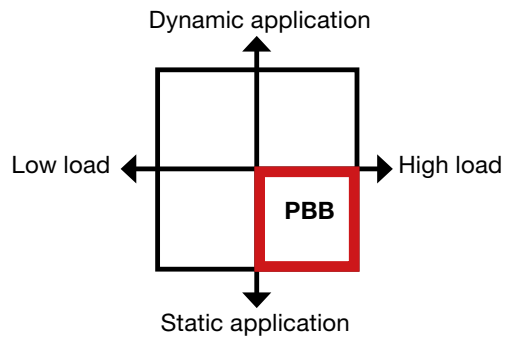

CHOOSE THE RIGHT BLOCK FOR YOUR APPLICATION

Plain bearing blocks provide great performance in static applications with heavy loads. Available in 16, 20, 40, 50, 60, 70, 80 and 100 mm sheave diameters.

PBB 16,
page 14



PBB 20,
page 14



PBB 40,
pages 15
PBB 50,
pages 16-17



PBB 60,
pages 18-19
PBB 70,
pages 20-21
PBB 80,
pages 22-23

PBB 100,
pages 24-25



PBB 60/80
Quick lock,
pages 26-27





AISI 316 stainless steel shackle

AISI 316 stainless steel shaft

AISI 316 stainless steel strap for increased safety
PBB 50 – PBB 80

Torsional rigid cheeks in glass fibre reinforced polymer to prevent jamming

AISI 316 stainless steel shaft



Practical switch from swivelling to fixed shackle
PBB 50/60/70/80.

Polymer bushing
PBB 70/80

Polymer sheave
PPB 20/40/50/60.
Glass fibre reinforced sheave PBB 70/80

PLAIN BEARING BLOCK

16/20



TECHNICAL FEATURES PBB 16

- A small stainless block designed for flag lines, lazy jacks and similar applications.
- Fixed strap for lashing.
- Available with two alternative sheaves, composite or brass.

TECHNICAL FEATURES PBB 20

- Polymer sheave
- Torsional rigid cheeks in glass fibre reinforced polymer to prevent jamming.

1 PBB 16 Single 2



3 PBB 20 Single strap



4 PBB 20 Flip flop



PBB 16

	Art. No.	Description	Weight (g)	Safe working load (kg)	Breaking load (kg)	Max line size (mm)
1	401-001-01R	Single, Composite	4	70	140	6
2	401-001-02R	Single, Brass	10	100	200	6

PBB 20

	Art. No.	Description	Weight (g)	Safe working load (kg)	Breaking load (kg)	Max line size (mm)	Fasteners (Ø mm)
3	402-001-01R	Single strap	6	70	140	6	
4	402-001-02R	Flip flop	25	70	140	6	c-c 45 mm Fasteners: M5 bolts or 4,8 mm pop rivets.



PLAIN BEARING BLOCK 40

TECHNICAL FEATURES PBB 40

- Polymer sheave
- Stiff glass fibre reinforced cheeks to prevent lines from jamming.

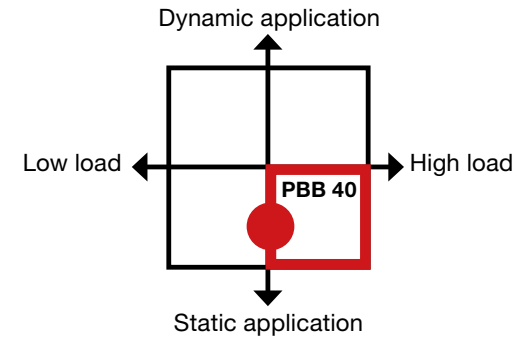

Fixed or swivelling shackle



A special insert is used to locate the shackle at 0° or 90°. When removed the shackle spins freely. See page 94 for more information.

PBB 40

	Art. No.	Weight (g)	Safe working load (kg)	Breaking load (kg)	Max line size (mm)
1	404-001-01R	68	350	700	8
2	404-001-02R	76	350	700	8
3	404-001-25R	53	350	700	8
4	404-001-11R	83	350	700	8



PLAIN BEARING BLOCK 50

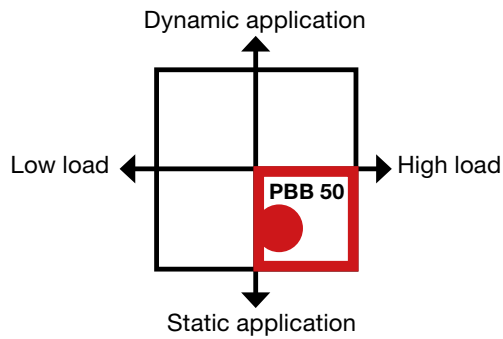

TECHNICAL FEATURES PBB 50

- Polymer sheave.
- Stainless steel strap for strength and long service life.
- Torsional rigid cheeks in glass fibre reinforced polymer to prevent jamming.
- Sliding swivel locking mechanism.

1



Single

2



Single becket

3



Single cam

4



Single becket cam

5



Double

6



Double becket

7



Triple

8



Triple becket

9



Triple cam

10



Triple becket cam

11



Fiddle

12



Fiddle becket

13



Fiddle cam

14



Fiddle becket cam

15



Cheek

16



Cheek R260

17



Cheek R40

For more information about dimensioning,
see page 102.

18



Fiddle, twin-cam

For endless furling line used for Seldén CX and GX furling systems.

PBB 50

	Art. No.	Weight (g)	Safe working load (kg)	Breaking load (kg)	Max line size (mm)	Shackle/fasteners (Ø mm)
1	405-001-01R	113	650	1300	12	5
2	405-001-02R	129	650	1300	12	5
3	405-001-03R	195	120*	240	12	5
4	405-001-04R	212	240*	480	12	5
5	405-001-05R	217	650	1300	12	5
6	405-001-06R	233	650	1300	12	5
7	405-001-07R	292	650	1300	12	5
8	405-001-08R	306	650	1300	12	5
9	405-001-09R	426	600*	1200	12	5
10	405-001-10R	440	650	1300	12	5
11	405-001-11R	150	650	1300	12	5
12	405-001-12R	161	650	1300	12	5
13	405-001-13R	234	360*	720	12	5
14	405-001-14R	244	480*	960	12	5
15	405-001-15R	80	650	1300	12	3xM5 (not included)
16	405-001-16R	81	650	1300	12	3xM5 (not included)
17	405-001-17R	81	650	1300	12	3xM5 (not included)
18	405-001-40R	355	120*	240	10	405-040-01R

* Safe working load based on Cam cleat 433-201-01.



PLAIN BEARING BLOCK 60

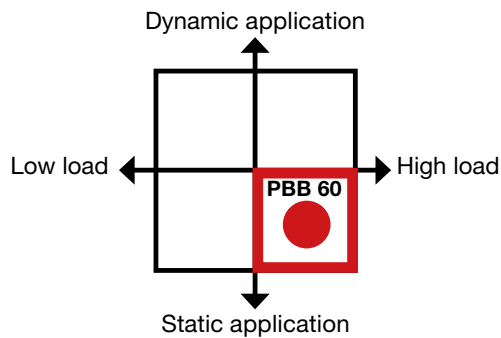

TECHNICAL FEATURES PBB 60

- Polymer sheave.
- Stainless steel strap for strength and long service life.
- Torsional rigid cheeks in glass fibre reinforced polymer to prevent jamming.
- Sliding swivel locking mechanism.

1



Single

2



Single becket

3



Single cam

4



Single becket cam

5



Double

6



Double becket

7



Triple

8



Triple becket

9



Triple cam

10



Triple becket cam

11



Fiddle

12



Fiddle becket

13



Fiddle cam

14



Fiddle becket cam

15



Cheek

16



Cheek R345

17



Cheek R48

18



Double cheek

19

Fiddle, twin-cam
For Seldén CX and GX
furling systems.

20

Single with bow
shackle

For more information about
dimensioning, see page 102.

PBB 60

	Art. No.	Weight (g)	Safe working load (kg)	Breaking load (kg)	Max line size (mm)	Shackle/fasteners (Ø mm)
1	406-001-01R	189	1000	2000	14	6
2	406-001-02R	211	1000	2000	14	6
3	406-001-03R	286	120**	240	12	6
4	406-001-04R	308	240**	480	12	6
5	406-001-05R	357	1000	2000	14	6
6	406-001-06R	378	1000	2000	14	6
7	406-001-07R	500	1000	2000	14	6
8	406-001-08R	524	1000	2000	14	6
9	406-001-09R	658	600**	1200	12	6
10	406-001-10R	670	720**	1440	12	6
11	406-001-11R	254	1000	2000	14	6
12	406-001-12R	271	1000	2000	14	6
13	406-001-13R	350	360**	720	12	6
14	406-001-14R	369	480**	960	12	6
15	406-001-15R	141	1000	2000	14	3xM6 (not included)
16	406-001-16R	137	1000	2000	14	3xM6 (not included)
17	406-001-17R	145	1000	2000	14	3xM6 (not included)
18	406-001-20R	292	1000*	2000*	14	3xM6 (not included)
19	406-001-40R	500	120**	240	12	406-040-01R
20	406-001-23R	195	1000	2000	14	6

* Upper sheave: Safe working load = 500 kg. Breaking load = 1000 kg.

** Safe working load based on Cam cleat 433-201-01.



PLAIN BEARING BLOCK 70



TECHNICAL FEATURES PBB 70

- Glass fibre reinforced sheave with polymer bushing.
- The shackle features a $\varnothing 6$ mm body and $\varnothing 8$ mm pin, a strong and lightweight combination.
- Stainless steel strap for strength and long service life.
- Torsional rigid cheeks in glass fibre reinforced polymer to prevent jamming.
- Sliding swivel locking mechanism.

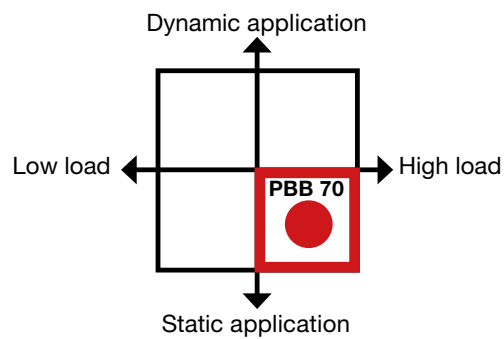



Single



Single becket



Double



Fiddle



Fiddle becket



PBB 70 double.

PBB 70

	Art. No.	Weight (g)	Safe working load (kg)	Breaking load (kg)	Max line size (mm)	Shackle (Ø mm)
1	407-001-01R	254	1500	3000	14	6/8
2	407-001-02R	285	1500	3000	14	6/8
3	407-001-05R	495	1500	3000	14	6/8
4	407-001-11R	372	1500	3000	14	6/8
5	407-001-12R	395	1500	3000	14	6/8

For more information about dimensioning, see page 102.



PLAIN BEARING BLOCK 80

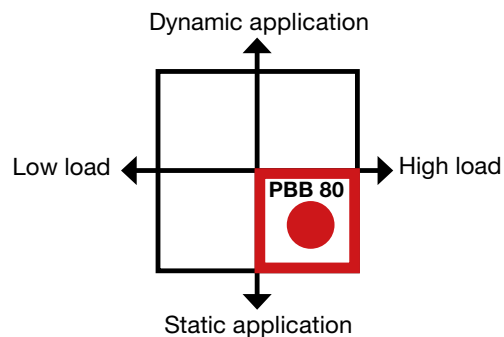

TECHNICAL FEATURES PBB 80

- Glass fibre reinforced sheave with polymer bushing.
- The shackle features a Ø 8 mm body and Ø 10 mm pin, a strong and lightweight combination.
- Stainless steel strap for strength and long service life.
- Torsional rigid cheeks in glass fibre reinforced polymer to prevent jamming.
- Sliding swivel locking mechanism.

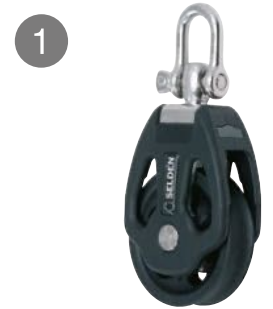

Single

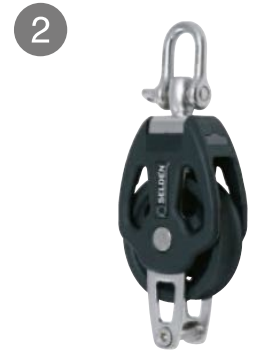

Single becket



Double

For more information about dimensioning, see page 102.

4



Double becket

7



Fiddle

10



Double cheek

5



Triple

8



Fiddle becket

6



Triple becket

9



Single cheek



PBB 80 Triple

PBB 80

	Art. No.	Weight (g)	Safe working load (kg)	Breaking load (kg)	Max line size (mm)	Shackle/fasteners (Ø mm)
1	408-001-01R	471	2000	4000	16	8/10
2	408-001-02R	524	2000	4000	16	8/10
3	408-001-05R	846	2000	4000	16	8/10
4	408-001-06R	901	2000	4000	16	8/10
5	408-001-07R	1154	2000	4000	16	8/10
6	408-001-08R	1204	2000	4000	16	8/10
7	408-001-11R	603	2000	4000	16	8/10
8	408-001-12R	638	2000	4000	16	8/10
9	408-001-15R	310	2000	4000	16	3xM8 (not included)
10	408-001-20R	628	2000 (lower sheave) 1000 (upper sheave)	4000 (lower sheave) 2000 (upper sheave)	16	3xM8 (not included)



PLAIN BEARING BLOCK 100

TECHNICAL FEATURES PBB 100

- A plain bearing block handling up to 4 ton load.
- The block features a plain bearing with polymer bushing and two axial Delrin® bearings to stabilize the sheave when the rope enters or exits the block with an angle.
- Machined, black anodised aluminium sheave and cheeks.
- All stainless parts are insulated from aluminium to prevent corrosion.
- The blocks are quick and easy to dismantle for maintenance.

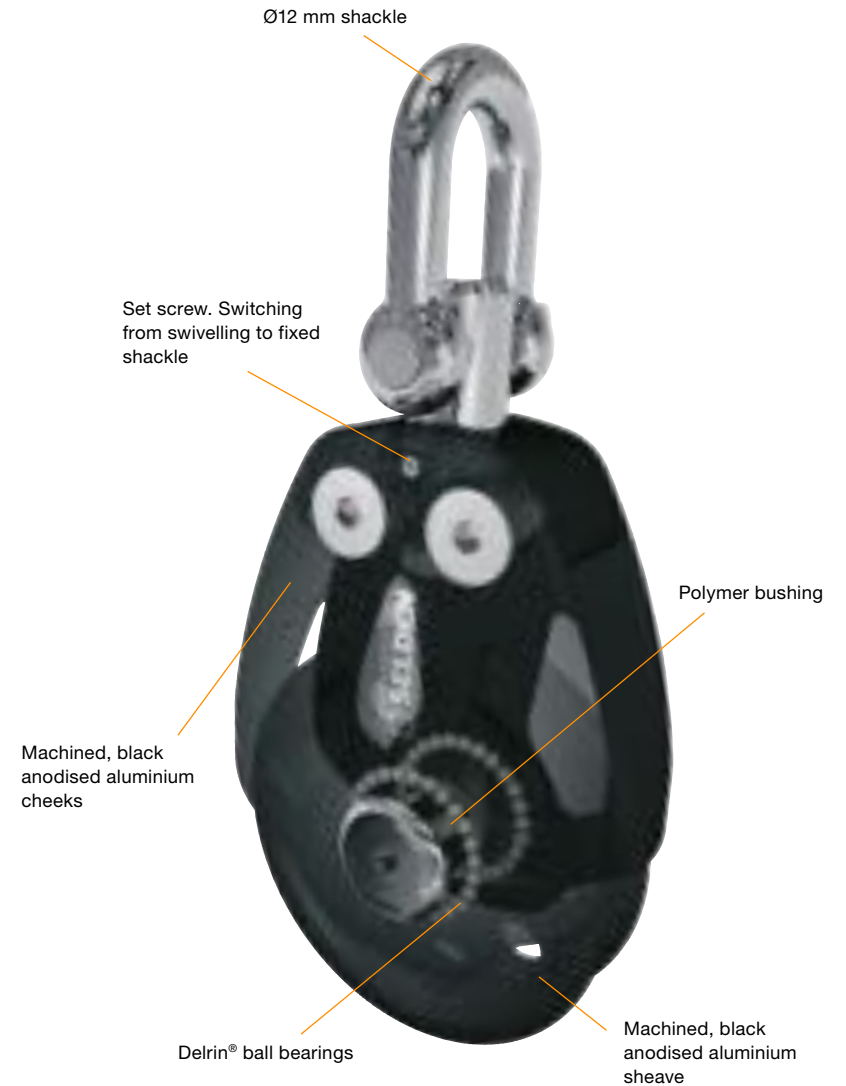
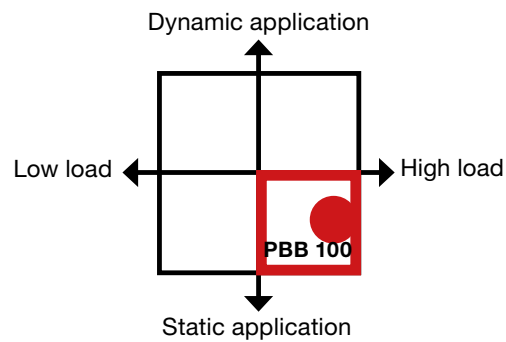



Single



Single swivel becket



Single halyard



Double



PBB 100 Cheek



Cheek



Double cheek

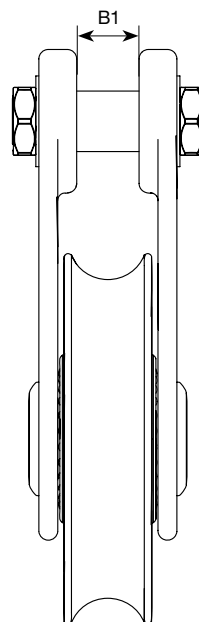

PBB 100

	Art. No.	Weight (g)	Width ^{B1} (mm)	Safe working load (kg)	Breaking load (kg)	Max line size (mm)	Shackle/fasteners (Ø mm)
1	410-001-01R	1030	-	4000	8000	20	12
2	410-001-02R	1100	-	4000	8000	20	12
3	410-001-03R	633	16.5	4000	8000	20	16 mm pin
4	410-001-04R	1750	-	4000	8000	20	12
5	410-001-15R	740	-	4000	8000	20	3xM10 (not included)
6	410-001-16R	1390	-	4000 (lower sheave) 2000 (upper sheave)	8000 (lower sheave) 4000 (upper sheave)	20	3xM10 (not included)

For more information about dimensioning, see page 102.



PLAIN BEARING BLOCK

60/80

QUICK LOCK

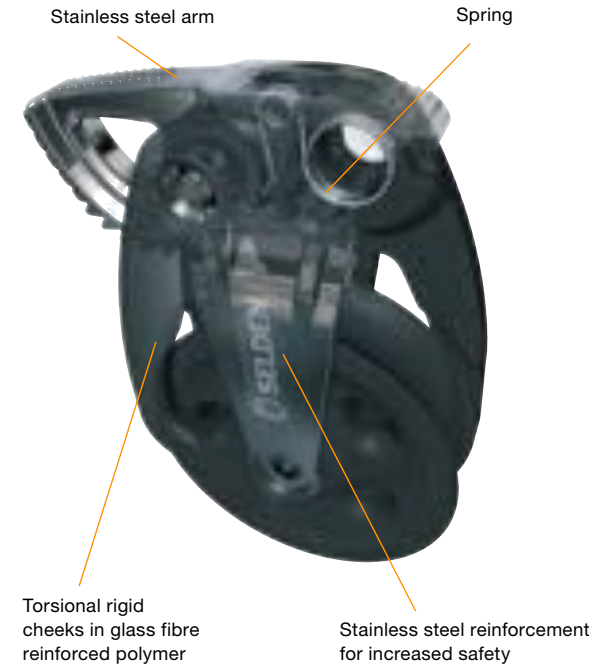

TECHNICAL FEATURES PBB 60/80 QUICK LOCK

- Spring loaded arm for precise and reliable locking operation. The spring holds the arm in open or closed positions.
- The Quick Lock function is intended for temporary use only, and does not replace a normal clutch or a cleat.
- Polymer sheave (PBB 60).
- Glass fibre reinforced sheave with polymer bushing (PBB 80).
- Torsionally rigid cheeks in glass fibre filled polymer prevent jamming of the line.
- Loads are absorbed by a stainless strap inside the cheeks. A safety feature quite typical for Seldén products.

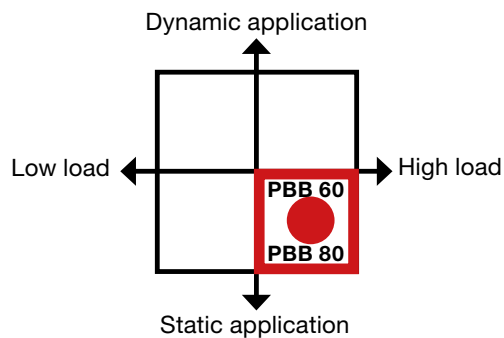

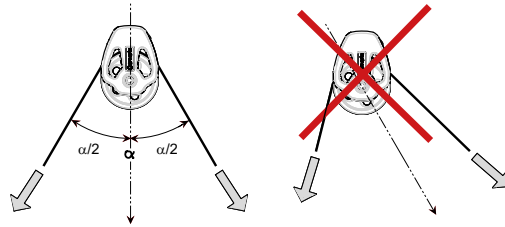

Fit cheek blocks so that they align with the direction of total load.

For more information about loads and hole patterns see page 100 and 107.



PBB Quick lock with spring loaded arm.

1 2



Single cheek with Quick lock, anti-clockwise

2 6



Double cheek with two Quick lock, anti-clockwise

3 7



Single cheek with Quick lock, clockwise

4 8



Double cheek with two Quick lock, clockwise

PBB 60 QUICK LOCK

	Art. No.	Weight (g)	Safe working load (kg)	Breaking load (kg)	Max line size (mm)	Fasteners
1	406-001-18R	198	1000	2000	14	3xM6 (not included)
2	406-001-19R	398	1000 (lower sheave) 500 (upper sheave)	2000 (lower sheave) 1000 (upper sheave)	14	3xM6 (not included)
3	406-001-21R	198	1000	2000	14	3xM6 (not included)
4	406-001-22R	398	1000 (lower sheave) 500 (upper sheave)	2000 (lower sheave) 1000 (upper sheave)	14	3xM6 (not included)

PBB 80 QUICK LOCK

	Art. No.	Weight (g)	Safe working load (kg)	Breaking load (kg)	Max line size (mm)	Fasteners
5	408-001-18R	395	2000	4000	16	3xM8 (not included)
6	408-001-19R	778	2000 (lower sheave) 1000 (upper sheave)	4000 (lower sheave) 2000 (upper sheave)	16	3xM8 (not included)
7	408-001-21R	395	2000	4000	16	3xM8 (not included)
8	408-001-22R	778	2000 (lower sheave) 1000 (upper sheave)	4000 (lower sheave) 2000 (upper sheave)	16	3xM8 (not included)



ROLLER BEARING BLOCK



ROLLER BEARING BLOCKS

Seldén Roller Bearing Blocks (RBB) ensure low resistance for high, dynamic loads. This performance range is ideal for spinnaker sheets, backstays and German sheeting. The blocks respond instantly to maintain delicate trimming and smooth manoeuvres so the sailor can focus on driving the boat forward.

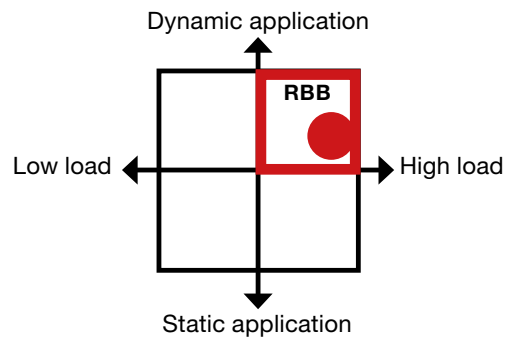



The winch feeder is used for leading a line to a free winch.

TECHNICAL FEATURES RBB 60/80

- Machined, black anodised aluminium cheeks and sheave.
- Torlon® roller bearings.
- Polymer washer insulates stainless from aluminium to prevent corrosion.
- Polymer thrust bearings for resisting side loads.
- Optimised shackle and pin combinations for strength and reduced weight.

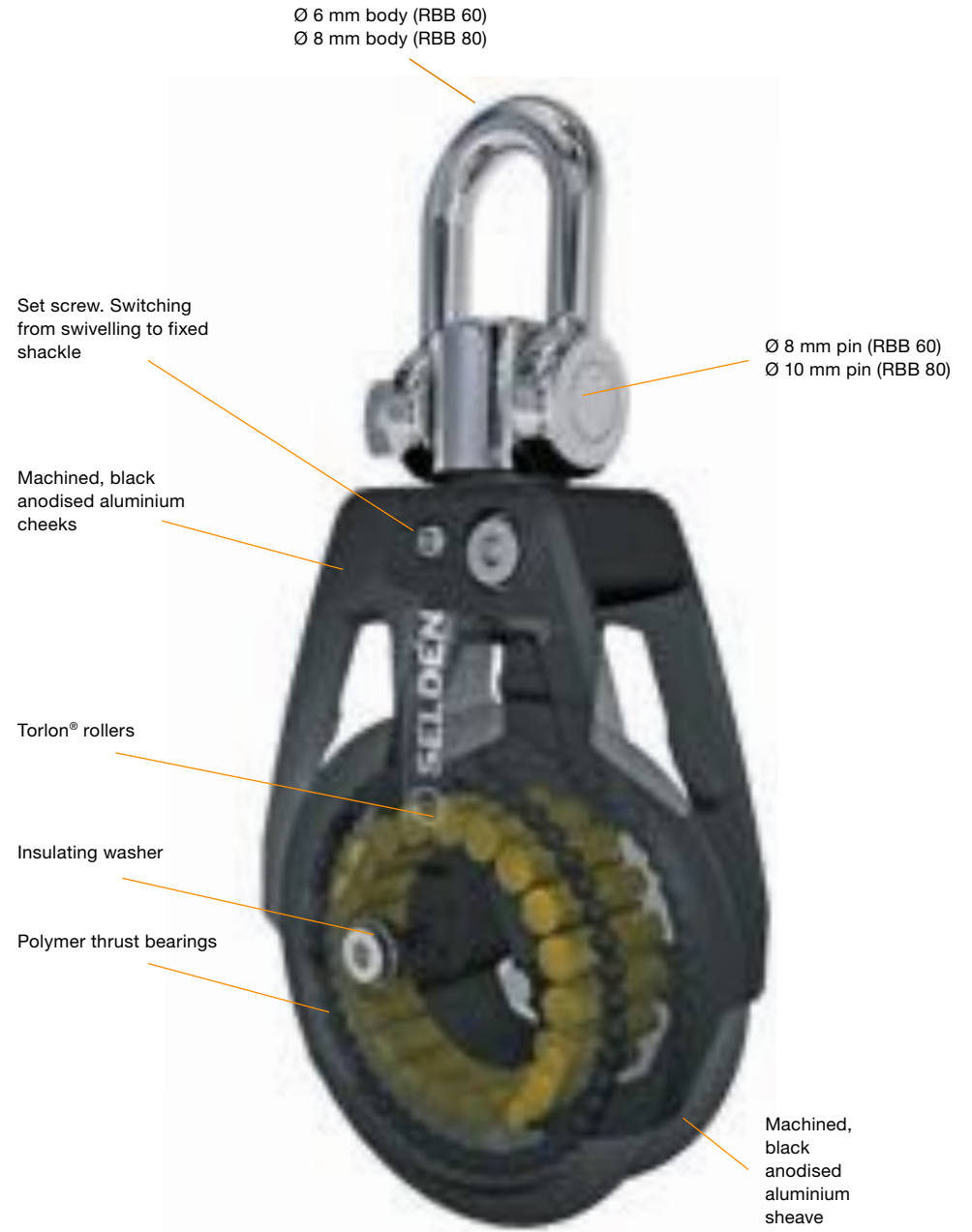



ROLLER BEARING BLOCK 60

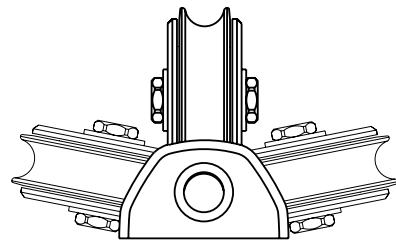
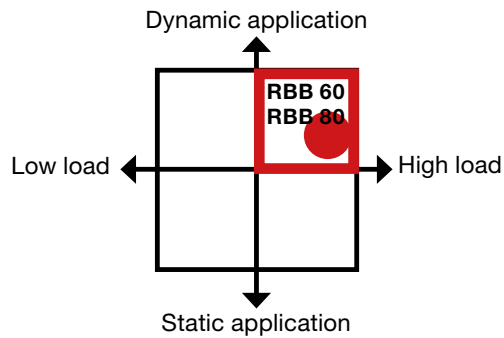
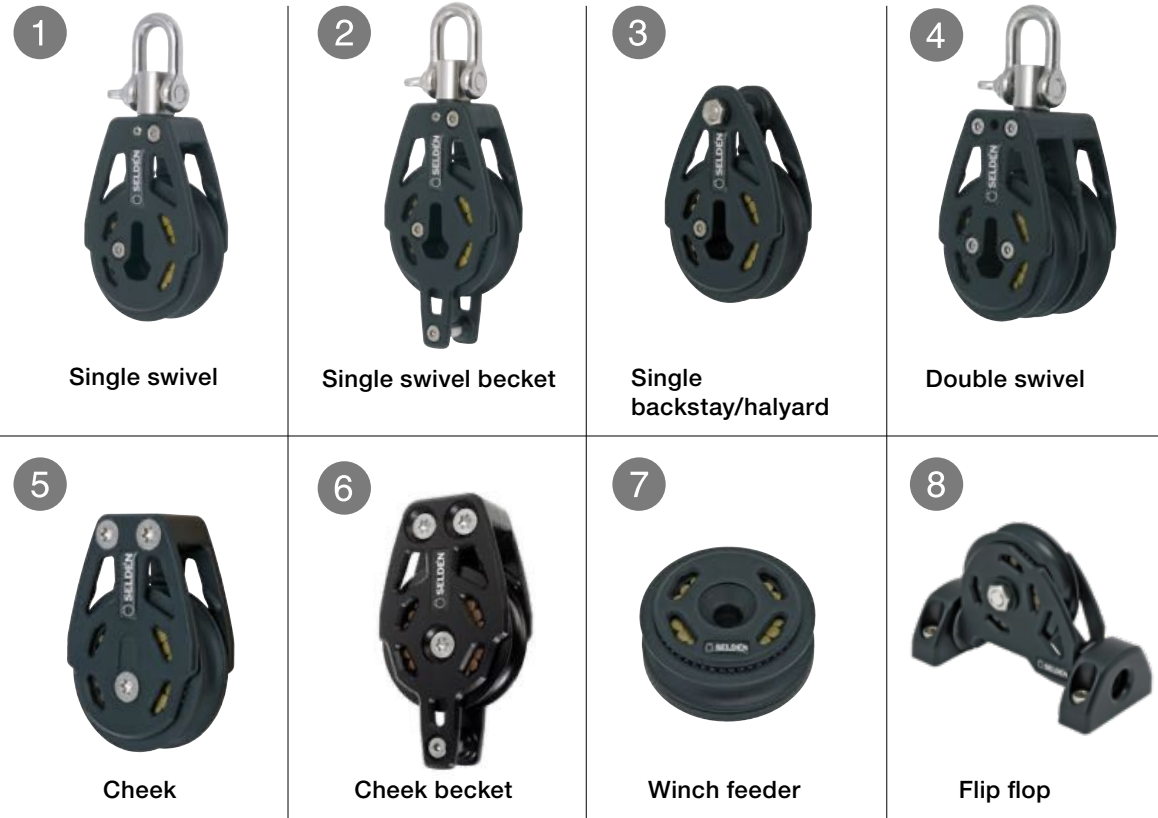

The flip flop block is ideal for leading a vertical line aft, perfect for German sheeting. The deck attachments are well rounded machined aluminium. Bushings between the shaft and the leads prevent rattling. The sheave is a RBB60 with Torlon roller bearings and polymer thrust bearings. The flip flop block has a great combination of low friction, flexibility and low chafe.

RBB 60

	Art. No.	Weight (g)	Width ^{B1} (mm)	Safe working load (kg)	Breaking load (kg)	Max line size (mm)	Shackle/ fasteners (Ø mm)
1	406-201-01R	205	-	1500	3000	12	6/8
2	406-201-02R	215	-	1500	3000	12	6/8
3	406-201-03R	135	14	1500	3000	12	8 mm shaft
4	406-201-05R	330	-	1500	3000	12	6/8
5	406-201-10R	209	-	1500	3000	12	3xM8 countersunk (not included)
6	406-201-11R	221	-	1500	3000	12	3xM8 countersunk (not included)
7	406-201-08R	126	-	1500	3000	12	1xM10 countersunk (not included)
8	406-201-09R	274	-	1350	2700	10	4xM6 (not included)

ROLLER BEARING BLOCK 80



Single swivel



Single swivel becket

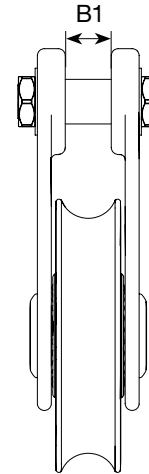

RBB 60 and RBB 80
Single backstay/halyard



Lubrication for Torlon®
ball bearings,
Art. No. 312-534-01R.



Single
backstay/halyard



Double swivel



Cheek

RBB 80

	Art. No.	Weight (g)	Width ^{B1} (mm)	Safe working load (kg)	Breaking load (kg)	Max line size (mm)	Shackle/fasteners (Ø mm)
1	408-201-01R	417	-	2500	5000	14	8/10
2	408-201-02R	430	-	2500	5000	14	8/10
3	408-201-03R	282	14.5	2500	5000	14	10 mm shaft
4	408-201-05R	667	-	2500	5000	14	8/10
5	408-201-07R	296	-	2500	5000	14	3xM8



BALL BEARING BLOCKS

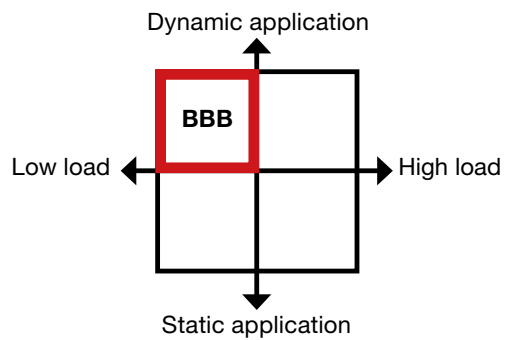

BBB 20,
pages 34-35



BBB 30,
pages 36-37



BBB 40,
pages 38-39



BBB 60,
pages 40-41



ARB 45,
pages 43



MRB 60,
pages 44



*Through deck block available in sizes
BBB 20, BBB 30 and BBB 40.
Suitable for dinghy and keelboat
control lines, and also for Furllex TD
furling line.*

TECHNICAL FEATURES BBB 20/30/40

- Stainless steel ball bearing races, stainless steel ball bearings and polymer sheave for best bearing strength under dynamic loads.
- Polymer bearing cages to prevent ball-to-ball friction and to reduce weight.

APPLICATIONS

Ball bearing blocks are typically used for medium and dynamic loads in:

- Control line applications
- Mainsail sheets for dinghies and keelboats
- Spinnaker sheets, barber haulers
- Genoa sheets
- Dinghy applications
- Vang applications

Fixed or swivelling shackle



A special insert is used to locate the shackle at 0° or 90°. When removed the shackle spins freely. See page 94 for more information.

BBB 30/40/60

Torsional rigid cheeks in glass fibre reinforced polymer to prevent jamming

AISI 316 stainless steel races

Big bearing diameter – less friction

Polymer ball bearing cages

AISI 316 stainless steel ball bearings



CASCADE SYSTEM

BBB 40

BBB 30

BBB 20





BALL BEARING BLOCK 20



1
Single strap



2
Single bucket strap

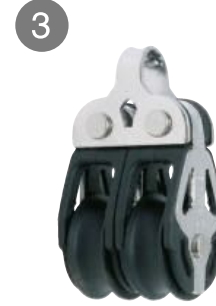

3
Double



4
Double bucket



5
Triple



6
Triple bucket



7
Triple cam



8
Triple bucket cam



9
Single fixed shackle



10
Single stand-up
(incl. ① 2-P eye 403-122,
② stand-up spring
403-123)



11
Double stand-up
(incl. ① 2-P eye 403-122,
② stand-up spring
403-123)

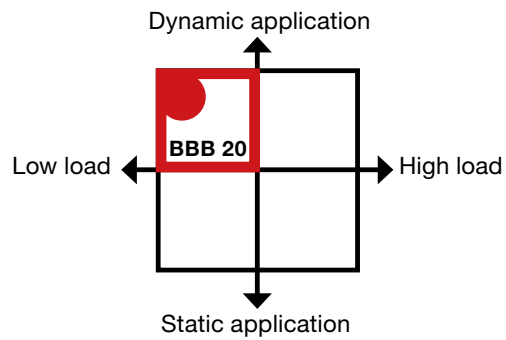

TECHNICAL FEATURES BBB 20

- Stainless steel strap to ensure high strength and stiff sides.
- Stainless steel ball bearings and polymer sheave for best bearing strength even under high dynamic loads.
- Glass fibre reinforced polymer cheeks.
- 12 → 16 Polymer ball bearings for low weight.



BBB 20 Cheek and single tie-on are ideal for sail applications.



12



Single tie-on

13



Single cheek

14



Single lead

15



Single through deck

16



Double through deck

17



Trapeze ring assy

18



Single strap with tang

FITTING BBB 20 TIE-ON

BBB 20 tie-on can be fitted in three different ways. Note that the safe working load of the block is reduced by 50% when the block is fitted as in picture 3.



BBB 20

	Art. No.	Weight (g)	Safe working load (kg)	Breaking load (kg)	Max line size (mm)	Shackle/fasteners (Ø mm)
1	402-101-01R	14	150	300	6	-
2	402-101-02R	16	150	300	6	-
3	402-101-03R	35	300	600	6	-
4	402-101-04R	36	300	600	6	-
5	402-101-05R	52	300	600	6	-
6	402-101-06R	54	300	600	6	-
7	402-101-07R	98	300	600	6	-
8	402-101-08R	100	300	600	6	-
9	402-101-09R	22	150	300	6	4
10	402-101-14R	18	150	300	6	2xM4 (not included)
11	402-101-15R	39	200	400	6	2xM4 (not included)
12	402-101-12R	7	100*	200*	6	-
13	402-101-13R	6	100	200	6	2xM4 (not included)
14	402-101-16R	8	100	200	6	2xM4 (not included)
15	402-101-17R	9	100	200	6	2xM4 (not included)
16	402-101-18R	17	100	200	6	2xM4 (not included)
17	402-101-19R	62	150	350	6	-
18	402-101-20R	17	150	300	6	1xM4 (not included)

*Safe working load = 50 kg, breaking load = 100 kg when the BBB 20 is fitted as in picture 3 (above).



BALL BEARING BLOCK 30

1



Single swivel/fixed

2



Single strap

3



Single swivel/ fixed, becket

4



Double loop head

5



Double loop head becket

6



Triple loop head becket

7



Triple loop head becket cam

8



Single tie-on

9



Single cheek

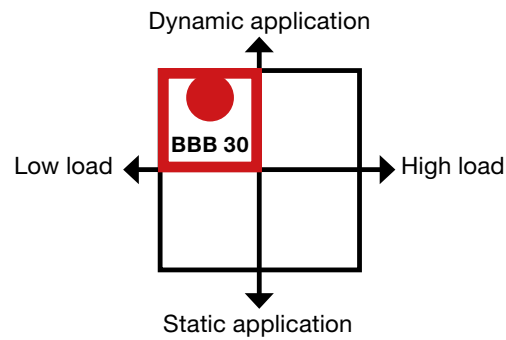

TECHNICAL FEATURES BBB 30

- Stainless steel ball bearing races, stainless steel ball bearings and polymer sheave for best bearing strength under dynamic loads.
- Polymer bearing cage to prevent ball-to-ball friction and to reduce weight.
- Glass fibre reinforced polymer cheeks.

10



Triple becket

11



Triple cam

12

Single swivel,
stand up

13



Single becket strap

14



Clew block

15

Sheet block, swivel
with slot. (Incl. in
403-101-12R and
System 15)

16



Single through deck

17



Single lead

18

Double through
deck

19



Linked BBB30/BBB20

*The centre hole can be
used as a becket.*

**BBB 30**

	Art. No.	Weight (g)	Safe working load (kg)	Breaking load (kg)	Max line size (mm)	Shackle/fasteners (Ø mm)
1	403-101-01R	33	200	400	8	4
2	403-101-02R	24	200	400	8	-
3	403-101-03R	35	200	400	8	4
4	403-101-04R	49	400	800	8	-
5	403-101-05R	52	400	800	8	-
6	403-101-06R	77	600	1200	8	-
7	403-101-07R	130	540*	1080	7	-
8	403-101-08R	21	200	400	8	-
9	403-101-09R	22	200	400	8	2xM4 (not included)
10	403-101-10R	79	600	1200	8	-
11	403-101-11R	126	450*	900	7	-
12	403-101-12R	30	200	400	8	2xM4 (not included)
13	403-101-13R	29	200	400	8	-
14	403-101-14R	68	200	400	8	Ring Ø35x5
15	403-101-16R	26	200	400	8	-
16	403-101-22R	24	200	400	8	2xM5 (not included)
17	403-101-23R	22	200	400	8	2xM5 (not included)
18	403-101-24R	44	200	400	8	2xM5 (not included)
19	403-101-15	38	150	300	8/6	-

* Safe working load based on Cam cleat 433-101-01.



BALL BEARING BLOCK 40



404-040-01R Snap shackle 40 makes it easy to remove the block when needed.

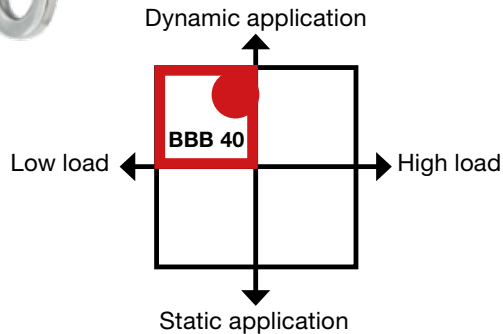

For more information about dimensioning, see page 102.

TECHNICAL FEATURES BBB 40

- Stainless steel ball bearing races, stainless steel ball bearings and polymer sheave for best bearing strength under high dynamic loads.
- Polymer bearing cage to prevent ball-to-ball friction and to reduce weight.
- Glass fibre reinforced polymer cheeks.

1



Single swivel/fixed

2



Single strap
(The strap can be removed)

3



Single swivel/fixed becket

4



Single swivel/fixed cam

5



Single swivel/fixed becket cam

6



Double loop head

7



Double loop head becket

8



Triple swivel

9



Triple swivel becket

10



Triple swivel cam

11



Triple swivel becket cam

12



Fiddle swivel/fixed cam

13

Fiddle swivel/fixed,
becket

14

Fiddle swivel/fixed
cam

15

Fiddle swivel/fixed
becket cam

16



Single tie-on

17



Single cheek

18



Fiddle hook cam

19



Fiddle hook cam eye

20

Single becket strap
(The strap can be
removed)

21



Linked BBB40/BBB30

22



Single through deck

23



Single lead

24



Double through deck

BBB 40

	Art. No.	Weight (g)	Safe working load (kg)	Breaking load (kg)	Max line size (mm)	Shackle/fasteners (Ø mm)
1	404-101-01R	55	250	500	10	4
2	404-101-02R	45	250	500	10	-
3	404-101-03R	60	250	500	10	4
4	404-101-04R	100	90*	180	7	4
5	404-101-05R	104	180*	360	7	4
6	404-101-06R	98	500	1000	10	-
7	404-101-07R	102	500	1000	10	-
8	404-101-08R	168	750	1500	10	5
9	404-101-09R	171	750	1500	10	5
10	404-101-10R	216	450*	900	7	5
11	404-101-11R	220	540*	1080	7	5
12	404-101-12R	66	250	500	10	4
13	404-101-13R	70	250	500	10	4
14	404-101-14R	107	250	500	7	4
15	404-101-15R	115	250	500	7	4
16	404-101-16R	48	250	500	10	-
17	404-101-17R	49	250	500	10	2xM5 (not included)
18	404-101-18R	118	250	500	10	-
19	404-101-19R	120	250	500	10	-
20	404-101-20R	50	250	500	10	-
21	404-101-21R	78	200	400	10/8	-
22	404-101-22R	53	250	500	10	2xM5 (not included)
23	404-101-23R	42	250	500	10	2xM5 (not included)
24	404-101-24R	93	250	500	10	2xM5 (not included)

* Safe working load based on Cam cleat 433-101-01.



BALL BEARING BLOCK 60

These blocks are designed with lightweight Delrin ball bearings for moderate loads. Alternatively, a Heavy Duty version is available with stainless steel ball bearings for higher dynamic load applications. The shackle is either fixed or swivelling. See page 94.

TECHNICAL FEATURES BBB 60

- Ø 5 mm Delrin ball bearings and Ø 60 mm polymer sheave.
- Cheeks made of glass fibre reinforced polymer.

TECHNICAL FEATURES BBB 60 HD (HEAVY DUTY)

- Ø 5 mm stainless ball bearings and Ø 60 mm polymer sheave.
- Stainless steel ball bearing races
- Polymer bearing cages to prevent ball-to-ball friction and to reduce weight.
- Cheeks made of glass fibre reinforced polymer.

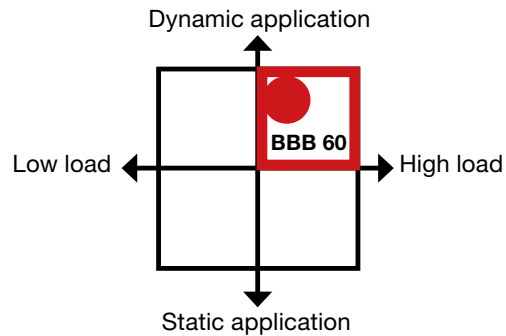

For more information about dimensioning, see page 102.

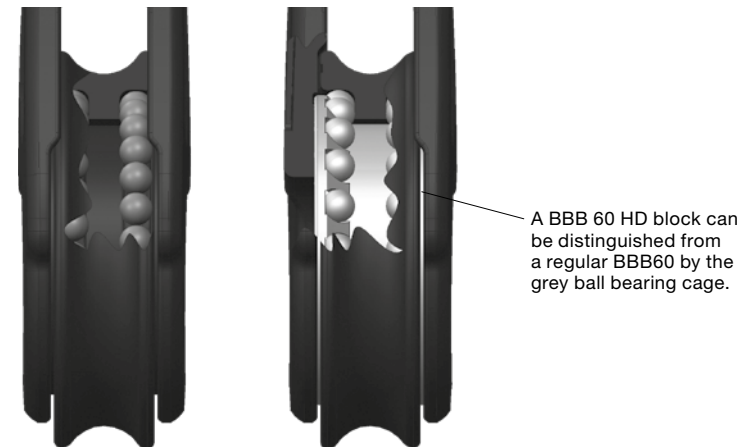
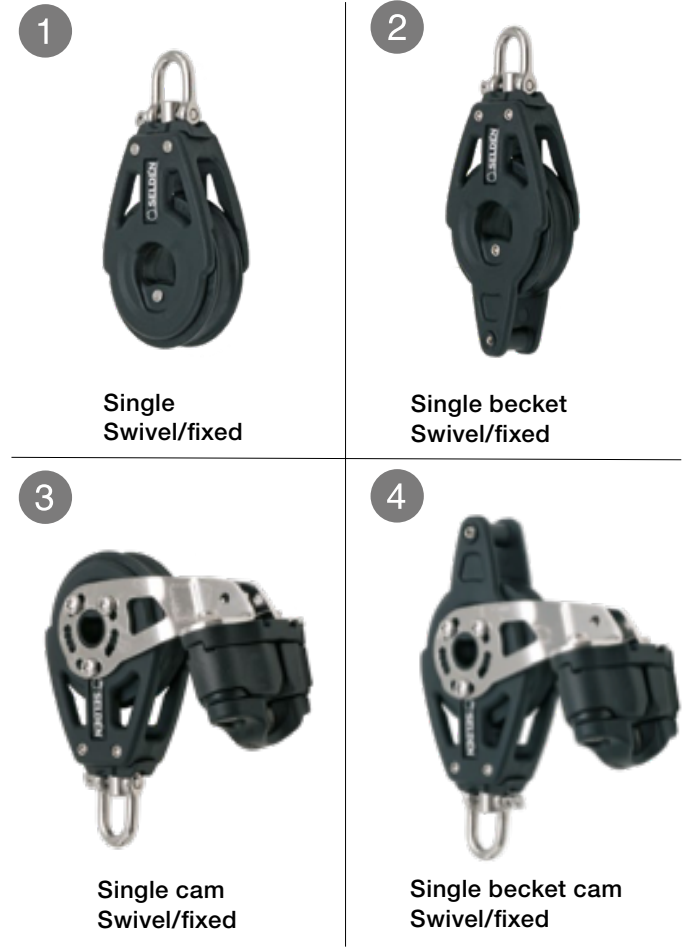



BBB 60, HEAVY DUTY

Stainless steel ball bearings

	Art. No.	Weight (g)	Safe working load (kg)	Breaking load (kg)
1	406-601-51R	146	500	1000
2	406-601-52R	158	500	1000
14	406-601-64R	114	500	1000
15	406-601-65R	114	500	1000



BBB 60

	Art. No.	Weight (g)	Safe working load (kg)	Breaking load (kg)	Max line size (mm)	Shackle/fasteners (Ø mm)
1	406-601-01R	115	350	1000	10	5
2	406-601-02R	126	350	1000	10	5
3	406-601-03R	266	120	240	10	5
4	406-601-04R	276	240	480	10	5
5	406-601-05R	233	700	1400	10	5
6	406-601-06R	327	1000	2000	10	5
7	406-601-07R	337	1000	2000	10	5
8	406-601-08R	495	600	1200	10	5
9	406-601-09R	505	720	1440	10	5
10	406-601-10R	155	500	1000	10	5
11	406-601-11R	165	500	1000	10	5
12	406-601-12R	306	360	720	10	5
13	406-601-13R	316	480	960	10	5
14	406-601-14R	83	350	1000	10	-
15	406-601-15R	85	350	1000	10	3xM6 (not included)





RATCHET BLOCKS



Fixed or swivelling shackle



ARB 45 and MRB 60. A special insert is used to locate the shackle at 0° or 90°. When removed the shackle spins freely. See page 94 for more information.

AUTOMATIC RATCHET BLOCK 45

TECHNICAL FEATURES ARB 45

- Ø 5 mm Delrin ball bearings and Ø 45 mm carbon fibre reinforced polymer sheave.
- The sheave automatically changes from free-turning to ratchet when the load increases. The sailor decides when the automatic ratchet kicks in by using an allen key to adjust a screw inside the sheave. Fast, simple, precise.

APPLICATIONS

- Dinghy main sheets.
- Dinghy spinnaker sheets



Automatic ratchet block, low load. When the block is low-loaded the ratchet mechanism is disengaged and the sheave spins free.



Automatic ratchet block, high load. When the load on the block increases the ratchet engages and the sheave is locked in one direction.

Use an allen key to adjust the sensitivity of the automatic ratchet.



1



Single

ARB 45

Art. No.	Weight (g)	Safe working load (kg)	Breaking load (kg)	Max line size (mm)	Shackle (Ø mm)
1 404-401-01R	64	150	300	8	4



MANUAL RATCHET BLOCK 60

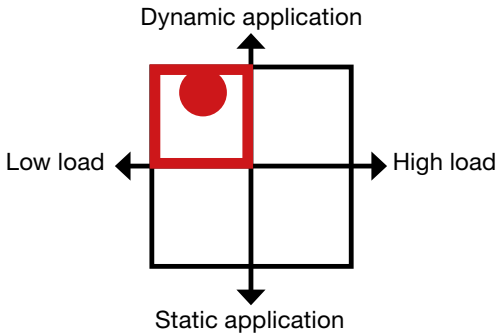

For dinghy main or spinnaker sheets. Makes it easy to advance your grip when hauling in the sheet. Also easier for a person holding the sheet. The perfect combination of control and convenience.



Single swivel/fixed



Single swivel/fixed becket

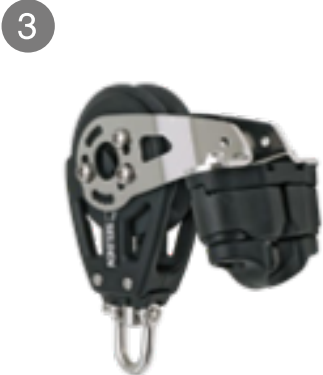

Single swivel/fixed cam



Single swivel/fixed becket cam



Single cheek, clockwise



Single cheek, anti clockwise



Fiddle swivel/fixe



Triple swivel/fixe cam with becket for fine tuning



Triple swivel/fixe becket cam



Fiddle swivel/fixe becket



Fiddle swivel/fixe cam with becket for fine tuning



Fiddle swivel/fixe becket cam

TECHNICAL FEATURES MRB 60

- Ø 5 mm Delrin ball bearings and Ø 60 mm carbon fibre reinforced polymer sheave.
- Manual switch for either ratchet function or free-turning.



Manual ratchet block 60. The grey switch is used to turn the ratchet function on/off.

MRB 60

	Art. No.	Weight (g)	Safe working load (kg)	Breaking load (kg)	Max line size (mm)	Shackle/fasteners (Ø mm)
1	406-301-01R	121	250	500	10	5
2	406-301-02R	132	250	500	10	5
3	406-301-03R	172	120	240	10	5
4	406-301-04R	283	240	480	10	5
5	406-301-05R	91	250	500	10	3xM6 (not included)
6	406-301-06R	91	250	500	10	3xM6 (not included)
7	406-301-07R	147	500	1000	10	5
8	406-301-08R	534	600	1200	10	5
9	406-301-09R	545	720	1440	10	5
10	406-301-10R	177	500	1000	10	5
11	406-301-12R	298	360	720	10	5
12	406-301-13R	318	480	960	10	5



HIGH LOAD BEARING BLOCK 25

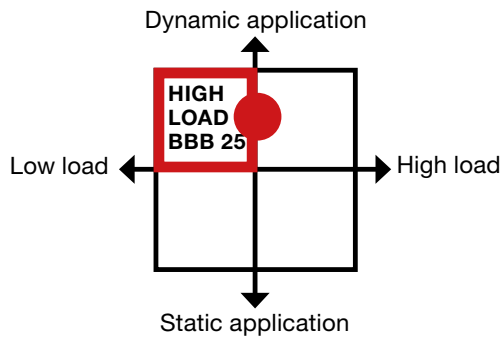

Single loop



Single



Single pin



Single becket



Double



Double becket



Triple



Triple becket

TECHNICAL FEATURES HIGH LOAD BBB 25

- Stainless steel sides to ensure high strength and stiffness.
- One row of stainless steel ball bearings.
- Ball cage to reduce ball-to-ball friction and weight.

APPLICATIONS

- Halyards
- Tackles
- Runners



High load BBB 25 Purchase 3:1

HIGH LOAD BBB 25

	Art. No.	Weight (g)	Safe working load (kg)	Breaking load (kg)	Max line size (mm)
1	402-201-04R	36	400	800	5
2	402-201-05R	30	400	800	5
3	402-201-06R	32	400	800	5
4	402-201-07R	34	400	800	5
5	402-201-08R	58	400	800	5
6	402-201-09R	62	400	800	5
7	402-201-10R	84	400	800	5
8	402-201-11R	86	400	800	5



HIGH LOAD PLAIN BEARING BLOCKS

45/60/ 80/100/130

1 → 5

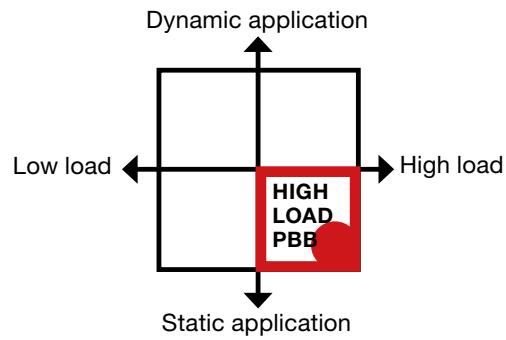

HIGH LOAD PBB

These blocks are optimised for wires or Dyneema®/ Spectra® core.

TECHNICAL FEATURES

- Stainless steel, electropolished sides
- Machined, black anodised aluminium sheaves
- Plain bearing polymer bushing
- External Stainless steel strengthening side plates
- Polyamide washers for wire terminal-block alignment

APPLICATIONS

- Designed for wire applications subject to rig loads, e.g. backstays.

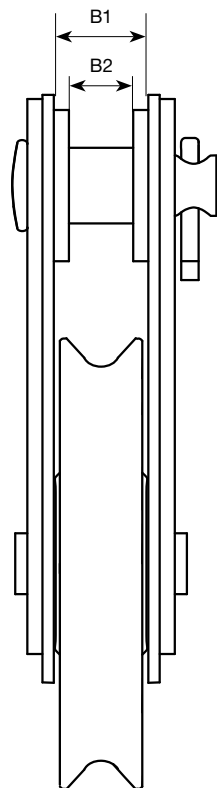

Dyneema core in the bridle is an alternative to 7x19 strand wire.

HIGH LOAD PBB 45/60/80/100/130

	Art. No.	Description	Weight (g)	Width ^{B1} (mm)	Width ^{B2} (mm)	Pin Ø (mm)	Safe working load (kg)	Breaking load (kg)	Max wire size (mm) Backstay	Max 7x19 wire dia. (mm) Bridle
1	404-201-01R	45	88	9.5	-	8 10 (incl. bush)	1100	2200	5	4
2	406-101-01R	60	192	12.5	8.5	8 10 (incl. bush)	1500	3000	6	5
3	408-101-01R	80	479	15.5	10.7	12.7	2750	5500	8	7
4	410-101-01R	100	812	15.5	12.5	16	4000	8000	10 ^{*)}	8
5	413-101-01R	130	1680	17.5	13.5	16 19 (incl. bush)	5500	11000	12 ^{*)}	10

^{*)} Note that max backstay wire capacity is higher than block and bridle capacity.

TRACKS AND TRAVELLERS



**TRAVELLER
SYSTEM 15**
pages 52-53



**TRACKS
SYSTEM 22, 30, 42**
pages 54-55



**TRAVELLER
SYSTEM 22**
pages 60-61



**TRAVELLER
SYSTEM 30**
pages 62-65



**TRAVELLER
SYSTEM 30
PERFORMANCE**
pages 66-69



**TRAVELLER
SYSTEM 42**
pages 70-71



COMBINATIONS
pages 72-77



**SELF TACKING
JIB SYSTEM**
page 78-81



**COMPLETE
SHEET
SYSTEMS**
page 82



TACKLES
page 83



Seldén's tracks and travellers have been engineered to meet the reliable, functional and elegant design that provides seamless interaction between the sailor and system. Whether a racing crew or pleasure cruiser, the ability to easily adjust the position of the traveller car ensures any sailor can maximise the performance available.



SYSTEM 15

Dinghy 22'

SYSTEM 22

20' 33'

SYSTEM 30

30' 45'

SYSTEM 42

40' 65'

The systems are available in four sizes 15, 22, 30 and 42. System size selection is determined by boat size.

For more information about dimensioning, see page 102.





SYSTEM 15

1 → 3



Track

4



Pinstop track

SYSTEM 15

Dinghy

22'

System 15 is used for dinghies and small keelboats up to approximately 22'.



TECHNICAL FEATURES SYSTEM 15

- The cars are black anodised, extruded aluminium. They run on Torlon ball bearings.
- AISI 316 stainless shackles suit BBB 30 and BBB 40 blocks.
- Car 441-101-02 has an integrated shackle that connects directly to the swivel post of the block.
- End stop 441-105 has an integrated becket for control lines.
- Jib car 441-103-01 feature captive slide rod bearings and it can easily be rebuilt for starboard/port installations. A tight tolerance on the track reduces vertical movement for easier uncleating. 50° adjustment of the cam cleat arm and 19 mm adjustment intervals sideways. The pinstop head is ergonomically designed for easy adjustment – even with cold hands.



5
Car with control block



6
Car with block and control block



7
Car with toggle and becket



8
Car with toggle



9
Tie-on car



10
Jib car with pinstop located to starboard



11
Jib car with pinstop located to port



12
End cap



13
End stop for pinstop track



14
Single strap with tang, BBB 20



15
Sheet block, swivel with slot, BBB 30



16
1-P eye

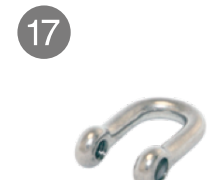

17
Toggle main car

TRACKS

	Art. no.	Weight (g)	Length (mm)	Width (mm)	Fasteners
1	441-001-01	122	600	15	M4
2	441-001-02	205	1000	15	M4
3	441-001-03	302	1500	15	M4
4	441-002-01	59	300	15	M5

CARS

	Art. no.	Weight (g)	Safe working load (kg)	Breaking load (kg)	Length (mm)	Width (mm)
5	441-101-01	84	120	400	112	42.5
6	441-101-02	109	120	400	112	42.5
7	441-101-03	60	120	400	68	42.5
8	441-101-04	50	120	400	57	42.5
9	441-102-01	40	120	400	56.6	42.5
10	441-103-01	165	120	240	68	7.5
11	441-103-02	165	120	240	68	7.5
12	441-105	5	-	-	27	24
13	441-106	23	-	-	20	20

ACCESSORIES

	Art. no.	Weight (g)	Safe working load (kg)	Breaking load (kg)	Length (mm)	Width (mm)
14	402-101-20R	17	150	300	46	20
15	403-101-16R	26	200	400	56	30
16	508-387R	5	-	-	24	10
17	441-113R	5	200	400	25	7



TRACK SYSTEM

22
30
42

APPLICATIONS

- The standard track is used for cars adjusted with control lines and for self-tacking systems.
- The pinstop track is used for pinstop genoa cars. Pinstop is a spring loaded plunger fixing the genoa car on the purpose made track. The car is easy to relocate when not under load.
- The high beam track is used for unsupported main sheet systems and self tacking systems.

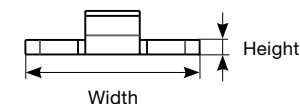

UPGRADING TO NEW TRACKS

The sliding bolt track is ideal for retrofit upgrades. The fasteners can be located according to the existing bolt holes. This track is also used for applications where the bolts are to be hidden.

SYSTEM 22

20'	33'
-----	-----

SYSTEM 30

30'	45'
-----	-----

SYSTEM 42

40'	65'
-----	-----

Track size selection is determined by boat size.

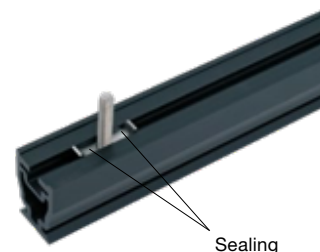
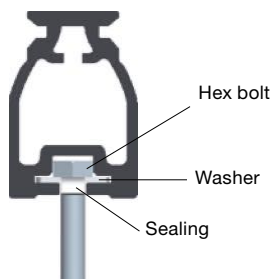

The bolt (DIN standard*) is inserted in the track with the washer fitted. Sealing compound is applied between the flanges of the washer. The track turns up-side-down and is then mounted on deck.

* N.B. Use ISO standard for high beam 42.

For information about length of unsupported track, see page 106.



SEALING WASHER

	Art. no.	Description	Width x height (mm)	Track Art. no.
1	164-481	Washer M5 Sliding bolt	10x1.2	442-003-0X
2	164-482	Washer M6 Sliding bolt	18x1.6	442-011-0X 443-003-0X
3	164-483	Washer M8 Sliding bolt	24x2	443-011-0X 444-003-0X
4	164-484	Washer M10 Sliding bolt	30x2.5	444-011-0X

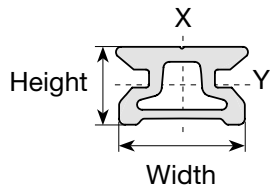
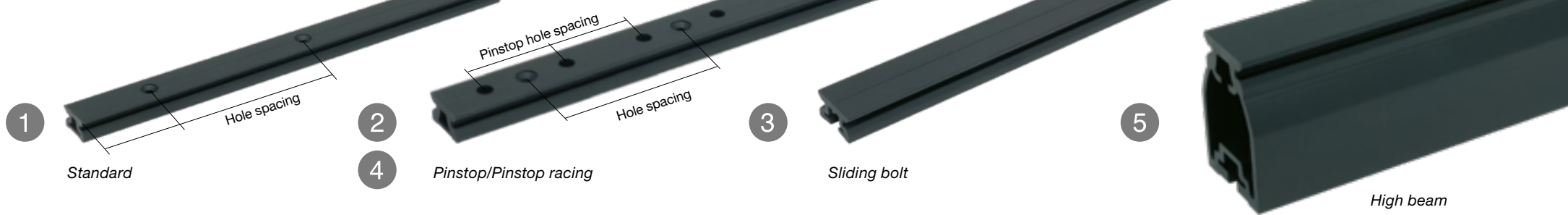

TRACK Standard
22, 30, 42

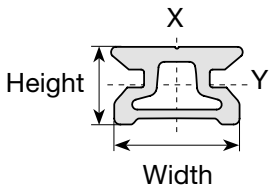

TRACK Pinstop
22, 30, 42

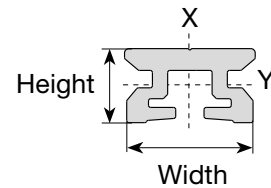

TRACK Sliding bolt
22, 30, 42

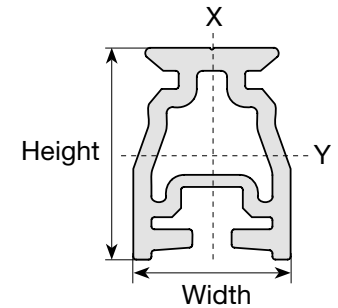

TRACK High beam
22, 30, 42

Length mm	TRACK 22					TRACK 30				TRACK 42			
	1	2	3	4	5	1	2	3	5	1	2	3	5
	Standard Art. no.	Pinstop Art. no.	Sliding bolt Art. no.	Pinstop Racing Art. no.	High beam Art. no.	Standard Art. no.	Pinstop Art. no.	Sliding bolt Art. no.	High beam Art. no.	Standard Art. no.	Pinstop Art. no.	Sliding bolt Art. no.	High beam Art. no.
300	-	-	-	442-004-01	-	-	-	-	-	-	-	-	-
500	-	-	-	442-004-03	-	-	-	-	-	-	-	-	-
1000	442-001-01	442-002-01	-	442-004-04	-	443-001-01	443-002-01	-	-	-	-	-	-
1200	442-001-02	442-002-02	-	-	-	443-001-02	443-002-02	-	-	-	-	-	-
1500	442-001-03	442-002-03	-	-	442-011-03	443-001-03	443-002-03	-	443-011-03	444-001-03	444-002-03	-	-
2000	442-001-04	442-002-04	442-003-04	-	442-011-04	443-001-04	443-002-04	443-003-04	443-011-04	444-001-04	444-002-04	444-003-04	444-011-04
2500	442-001-05	442-002-05	-	-	-	443-001-05	443-002-05	-	-	444-001-05	444-002-05	-	444-011-05
3000	442-001-06	442-002-06	442-003-06	-	-	443-001-06	443-002-06	443-003-06	-	444-001-06	444-002-06	444-003-06	-
3500	442-001-07	442-002-07	-	-	-	443-001-07	443-002-07	-	-	444-001-07	444-002-07	-	-
4000	442-001-08	442-002-08	442-003-08	-	442-011-08	443-001-08	443-002-08	443-003-08	443-011-08	444-001-08	444-002-08	444-003-08	444-011-08
6000	442-001-09	442-002-09	-	-	-	443-001-09	443-002-09	-	-	444-001-09	444-002-09	444-003-09	-
Weight Kg/m	0.43		0.45	0.43	1.07	0.89			2.62	1.65			4.47
Width/height mm	22/13				26/35	30/17			42/62	42/22			58/85
Wx/Wy cm ³	0.57/0.38		0.64/0.36	0.57/0.38	2.10/2.76	1.66/1.07		1.59/0.92	8.4/12.9	4.47/2.62		4.43/2.35	19.2/33
lx/ly cm ⁴	0.63/0.28		0.70/0.27	0.63/0.28	2.73/4.83	2.48/0.99		2.38/0.88	17.7/42.8	9.39/3.11		9.31/2.88	55.8/147
Screw size*	M5				M6	M6 (M8 on request)			M8	M10		M8	M10
Pinstop spacing, c-c (mm)	-	50	-	25	-	-	50	-	-	-	50	-	-
Hole spacing, c-c (mm)	100		max 100	100	max 100, see USL page 106	100		max 100	max 100, see USL page 106	100		max 100	max 100, see USL page 106

*Fasteners not included.

For curved tracks, please download enquiry form 595-952-E from www.seldenmast.com.



SYSTEM

22
30
42



When developing the Seldén range of tracks and travellers, reliability and ease of use has been our main focus. But we also made them appealing to the eye. They will enhance the performance, looks and the quality of any boat. Available for 20' keelboats up to 65' yachts.

APPLICATIONS

- Main sheet systems
- Genoa sheet systems
- Self tacking systems

LOADS

Max working load for end controls are in line with corresponding main sheet car or genoa car.

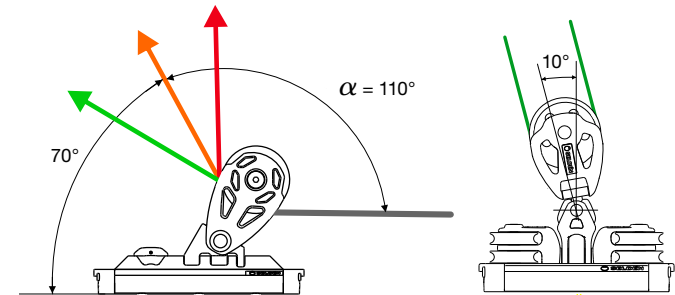

The load on a genoa car depends on the righting moment of the yacht and the sheet angle. A big overlapping 150% genoa has a flat angle of approximately 45°, and a 110% high performance jib will have a steep angle close to 80°. All safe working loads for Seldén genoa cars are based on 70° sheet angle, which gives a total deflection angle (α) of 110°. All safe working loads on Seldén main cars and self tacking cars are based on 10° sheet angle.

MAIN SHEET SYSTEM

The toggle and sheet block are supported by a rubber stand-up collar to improve function and dampens vibrations.

AISI 316 mirror finished stainless toggles for Seldén PBB and RBB blocks.

Plain bearing polymer sheaves for control lines.

The main sheet car is black anodised, extruded aluminium and runs on Torlon® ball bearings.

Black laquered aluminium or glass fibre reinforced polymer with rubber shock absorbers and integrated beackets for control lines. Plain bearing polymer sheaves in the composite sheave house and 3:1, 4:1 or 6:1 purchase depending on size of system. Available with or without integrated cam cleats.

Integrated beacket for control line.

Rubber shock absorber.

The high beam adaptor can be used to finish off a high beam track.





LOW FRICTION, LOW WEIGHT AND LONG LIFE

The cars are machined to allow the Torlon® bearings to run smoothly in a seamless ball bearing race.

LOW MAINTENANCE

A slot in the car makes it easy to remove salt and dirt from the ball bearings. Simply rinse with fresh water while moving the car back and forth along the track.



GENOA SHEET SYSTEM

Set your trim. Smoothly rounded stainless attachment for a rubber cord pulling the car aft when not under load. An easy way to set your trim positions before the jib/genoa is set.



End controls come with plain bearing polymer sheaves and 3:1 or 4:1 purchase.

The toggle and sheet block are supported by a rubber stand-up collar to improve function and eliminate rattling.

Pinstop switch in locked position...

...and open.



The pinstop function is a spring loaded plunger fixing the pinstop genoa car on the purpose made track. The car is easy to relocate when not under load.



SYSTEM 22

SYSTEM 22

20' 33'

Seldén system 22 is used for keelboats and yachts up to approximately 33'. See all combinations at pages 72-73 and 76-77. For more information about dimensioning, see page 102.



Main car



Main car with cam

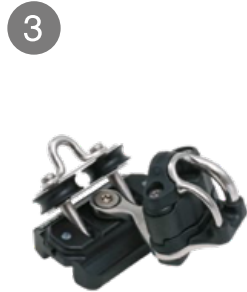

Main car, pivoting sheaves, cam cleat



Genoa car



Genoa car, pinstop

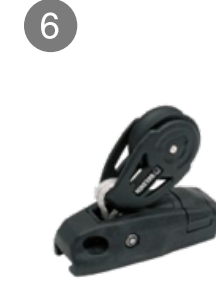

Jib car for use on Keelboats



Self tacking jib car



Double self tacking car



Tie-on car



Genoa end control



End control



End control, cam cleat, port



End control, cam cleat, starboard



End control with cheek



End cap



End stop



High beam adaptor

TECHNICAL FEATURES SYSTEM 22

- The main sheet car and the self-tacking car are black anodised, extruded aluminium and run on Torlon® ball bearings.
- The genoa car is black laquered aluminium with sliderods. Art. no. 442-150-01 is glass fibre reinforced polymer.
- Ø 30/40 mm plain bearing polymer sheaves for control lines.
- Genoa cars available for pinstop operation and for control lines.
- AISI 316 mirror finished stainless toggles suit Seldén PBB50 blocks, BBB 60 blocks and the MRB 60 block.
- The toggle/sheet block is supported by a rubber stand-up collar.
- Ø 50 mm plain bearing polymer sheave in the genoa car.
- Genoa car and end controls come with integrated becketts for control lines.
- Suitable max size of control line is Ø 7 mm.

This pin stop car offers a 2:1 purchase for the jib sheet. Ideal for keelboat sailors who will benefit from instant trim possibilities and not always be dependent on a winch. The pin-stop plunger is neatly streamlined with the car and it's easy to get a grip. The BBB 40 block is attached with a Dyneema lashing.

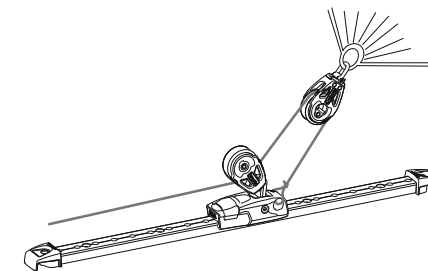

SYSTEM 22

	Art. no	Weight (g)	Safe working load ^{1), 2)} (kg)	Breaking load ²⁾ (kg)	Length (mm)	Width (mm)	Purchase	Combine with...
1	442-149-01	383	700	1400	130	57	4:1	PBB 50. For BBB 60 and MRB 60 only single, fiddle and becket block
2	442-149-02 ³⁾	610	700	1400	246	57	6:1	PBB 50. For BBB 60 and MRB 60 only single, fiddle and becket block
3	442-144-01	393	500	1000	85	57	2:1	
4	442-101-01	410	550	1100	108	49	3:1	
5	442-102-01	401	550	1100	99	49	-	
6	442-150-01	84	250	500	99	38	-	
7	442-148-01	387	700	1400	85	57	-	PBB 50. For BBB 60 and MRB 60 only single, fiddle and becket block
8	442-148-02	525	900	1800	178	57	-	PBB 50. For BBB 60 and MRB 60 only single, fiddle and becket block
9	442-143-01	264	700	1400				
10	442-103-01 ⁴⁾	60	-	-	64	30	4:1	
11	442-112-01 ⁴⁾	106	-	-	89	39	4:1/6:1	
12	442-112-02 ⁴⁾	169	-	-	89	85	4:1	
13	442-112-03 ⁴⁾	169	-	-	89	85	4:1	
14	442-112-04 ⁴⁾	85	-	-	89	39	2:1/3:1	
15	442-105 ⁴⁾	16	-	-	35	33	-	
16	442-138-01 ⁴⁾	23	-	-	51	40	-	
17	442-135	19	-	-	41	28	-	

¹⁾ 70°sheet angle on genoa car. ²⁾ Max working load for end controls are in line with corresponding main sheet car or genoa car. See system pages 72-73 and 76-77. ³⁾ Fits only single, fiddle and becket blocks. ⁴⁾ Fasteners not included.



SYSTEM 30

1



Main car

2



Main car with cam

3



Double main car

4



Triple main car

SYSTEM 30

30'

45'

Seldén system 30 is used for yachts up to approximately 45'. See all combinations at pages 72-77. For more information about dimensioning, see page 102.



*Tilt-absorber for genoa car
443-190-01/ 443-167-01, see page 76.
This prevents the unloaded sheave
house chafing on the coach
roof side.*

5



Genoa car

6



Genoa car, pinstop

7



Sheet lead



Genoa car ball bearing



Genoa car high load, pinstop



Self tacking jib car



Double self tacking jib car

TECHNICAL FEATURES SYSTEM 30

- The main sheet car and the self tacking car are black anodised, extruded aluminium and run on Torlon® ball bearings.
- The genoa car is either black laquered aluminium with sliderods or an extruded and anodised aluminium car with Torlon® ballbearings.
- Ø 40 mm plain bearing polymer sheaves for control lines.
- Genoa cars available for pinstop operation and for control lines.
- Main sheet car with Cam cleat 38.
- AISI 316 mirror finished stainless toggles for Seldén PBB 60, PBB 70 and RBB 60 blocks. Double self tacking car for PBB 80 and RBB 80.
- Ø 50/60 mm plain bearing polymer sheave in the genoa car.
- Suitable max size of control line is Ø 8 mm.

SYSTEM 30

	Art. no	Weight (g)	Safe working load ¹⁾ (kg)	Breaking load (kg)	Length (mm)	Width (mm)	Purchase	Combine with...
1	443-181-01	628	1500	3000	164	75	4:1	PBB 60, PBB 70, RBB 60
2	443-182-01	1017	1500	3000	281	75	6:1	PBB 60, PBB 70, RBB 60
3	443-185-01	1254	2000	4000	284	75	4:1	PBB 60, PBB 70, RBB 60
4	443-185-02	1363	2000	4000	284	75	4:1	PBB 60, PBB 70, RBB 60
5	443-117-01	455	700	1400	107	60	3:1	
6	443-126-01	432	700	1400	99	60	-	
7	443-126-02	435	700	1400	99	60	-	
8	443-190-01	790	1200	2400	180	75	4:1	
9	443-167-01	672	1200	2400	160	53	-	
10	443-179-01 ²⁾	395	1100	2200	117	75	-	PBB 60, PBB 70, RBB 60
11	443-179-02 ²⁾	1633	2000	4000	230	75		

¹⁾ 70°sheet angle on genoa car.

²⁾ For low track applications only (not high beam)



SYSTEM 30

TECHNICAL FEATURES SYSTEM 30 END FITTINGS

- Black laquered aluminium or glass fibre reinforced polymer with rubber shock absorbers and integral beckets for control lines.
- Composite end caps.
- Ø 40 mm plain bearing polymer sheaves in the composite sheave house.
- Cam cleat 38 end controls.
- End stop in polymer.

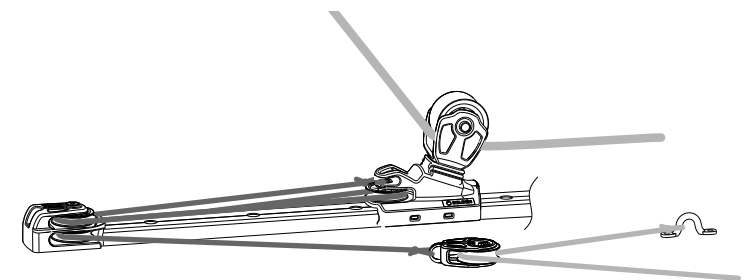
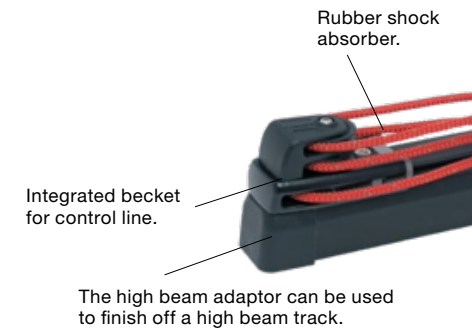

The purchase of the genoa control line is doubled when adding a block and a 2-p eye.

SYSTEM 30

30'

45'

Seldén system 30 is used for yachts up to approximately 45'. See all combinations at pages 72-77. For more information about dimensioning, see page 102.



End control



End control, Port



End control, Starboard



End control, single sheave



Genoa end control



End cap



high beam adaptor



End stop



End stop, heavy duty



End control with cam cleat

SYSTEM 30

	Art. no.	Weight (g)	Length (mm)	Width (mm)	Purchase/Fasteners
1	443-112-01	225	99	52	4:1/6:1
2	443-112-02	330	99	92	4:1
3	443-112-03	330	99	92	4:1
4	443-112-04	206	99	52	3:1/ 4:1
5	443-124-01	91	81	45	4:1
6	443-125	28	40	40	-
7	443-135	43	39	50	-
8	443-142-01	74	70	52	2xM6
9	443-166-01	103	77	52	2xM8

Fasteners not included. Max working load for end controls are in line with corresponding main sheet car or genoa car. See system pages 72-77.



SYSTEM 30 PERFORMANCE

Seldén system 30 Performance can be used for boats up to approximately 45'. When low friction and high purchase ratios are key requirements, this is the system to choose. An extra bonus is the sophisticated look created by a fine composition of black anodised aluminium, Torlon® ball bearings and stainless steel.

APPLICATIONS

- Main sheet systems
- Genoa sheet systems



The cam cleat angle can be fine tuned vertically and horizontally, leading the control line straight to the trimmer.

Control line led to a vertical lead block and further to a cam cleat.

MAIN SHEET SYSTEM

The cam cleat is angled towards the trimmer and the angle can be fine tuned by using wedges, 433-216-01R. It also has a horizontal adjustment. This results in excellent ergonomics and helps the trimmer to sail actively for long periods of time.

The main sheet sheave has a plain bearing for vertical loads and Torlon® ball bearings stabilize the sheave when subjected to side loads. This system is for German sheeting.

The control systems has a 6:1 purchase and aluminium sheaves with Torlon® ball bearings. When boat speed really counts, this is the way to go.

Aluminium sheaves with Torlon® ball bearings.

Low pivot point handles side loads and the sheave house articulates to align correctly with the sheet direction. Easy operation with low friction.

Stainless toggle.

Stainless stand-up spring.

Rubber shock absorbers.

Becket for control lines.

GENOA SHEET SYSTEM

The sheave house on a genoa car articulates 40° sideways, 8° aft/forward and can also twist to a certain extent. This enables the sheave to align correctly with the sheet direction. This is of great importance, particularly when the track is fitted on a curved surface between deck and cabin side. The low pivot-point reduces side loads and makes it easier to move the car under load.

Ball bearing end controls. The purchase can be 2:1, 4:1, 6:1 or 7:1.

Rubber bushing dampens vibrations.

Becket for rubber cord or to connect two genoa cars.

Stainless stand-up spring.





SYSTEM 30 PERFORMANCE

SYSTEM 30

30'

45'

Seldén system 30 Performance can be used for boats up to approximately 45'. See all combinations at pages 72-77. For more information about dimensioning, see page 102.



Main car fixed block

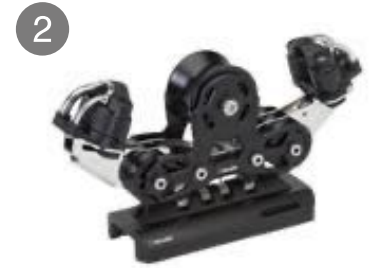

Main car fixed block with cam



Main car with toggle



Main car with toggle and cam



Main car fixed double sheaves



Main car with double toggle 8:1



Genoa car single sheave



Genoa car double sheaves



Genoa car with becket



Genoa car fiddle/becket



End control single sheave

12



End control double sheaves

13



End control fiddle

14



End control double fiddle

15



End control double fiddle/becket

16



End cap

17



High beam adaptor

SYSTEM 30 PERFORMANCE

TECHNICAL FEATURES SYSTEM 30 PERFORMANCE

- Torlon® ball bearing cars.
- All cars, end controls and sheave houses are black anodised extruded aluminium.
- Ø 30/40/50 mm trim sheaves with Torlon® ball bearings.
- Cam cleat 38 used for main sheet car and end controls.
- The toggle/sheet block is supported by a rubber stand-up collar.
- The main sheet sheave has a plain bearing for vertical loads and Torlon® ball bearings stabilize the sheave when subjected to side loads.
- Ø 60 mm plain bearing polymer sheave in the genoa car.
- Suitable max size of trim line is Ø 8 mm.
- AISI 316 mirror finished stainless toggles for Seldén PBB 60, PBB 70 and RBB 60 blocks.
- End controls with rubber shock absorbers and becketts for trim lines.
- Genoa car has a becket for rubber cord or to connect two cars.
- The sheave house of the genoa car is made of AISI 316 mirror finished stainless steel.

	Art. no.	Weight (g)	Safe working load ^{1) 2)} (kg)	Breaking load ²⁾ (kg)	Length (mm)	Width (mm)	Purchase	Combine with...
1	443-351-01	1691	1500	3000	160	75	6:1	End control 443-303-02
2	443-351-02	2055	1500	3000	260	75	6:1	
3	443-351-03	1491	1500	3000	160	75	6:1	End control 443-303-02
4	443-351-04	1418	1500	3000	260	75	6:1	Block PBB 70, RBB 60
5	443-351-05	2031	1000	2000	183	75	6:1	End control 443-303-02
6	443-355-01	2790	2000	4000	410	75	8:1	End control 443-304-03
7	443-350-01	1599	1500	3000	190	75	2:1	End control 443-303-01
8	443-350-02	1651	1500	3000	190	75	4:1	End control 443-303-02
9	443-350-03	1572	1500	3000	190	75	1:1	
10	443-352-01	1889	1500	3000	225	75	7:1	End control 443-304-02
11	443-303-01	353	-	-	95	53	4:1	
12	443-303-02	416	-	-	95	53	6:1	
13	443-304-01	295	-	-	120	53	6:1	
14	443-304-02	578	-	-	130	53	8:1	
15	443-304-03	563	-	-	130	53	8:1	Car 443-355-01
16	443-125 ³⁾	30	-	-	40	40	-	Fastener 1 x M6 bolt
17	443-135	57	-	-	37	50	-	

¹⁾ 70° sheet angle on genoa car. ²⁾ Max working load for end controls are in line with corresponding main sheet car or genoa car. See system pages 72-77. ³⁾ Fasteners not included.



SYSTEM 42

TECHNICAL FEATURES SYSTEM 42

- The main sheet car and the self tacking car are black anodised, extruded aluminium and run on Torlon® ball bearings.
- The genoa car is black anodised aluminium with slide rods and pinstop operated or with Torlon® ball bearings.
- The sheave house of the genoa car is AISI 316 mirror finished stainless steel.
- Ø 50 mm plain bearing polymer sheaves and composite sheave houses for control lines.
- Ø 80 mm genoa sheave.
- Cam cleat 38 used on end controls.
- AISI 316 mirror finished stainless toggles for Seldén PBB 80 and RBB 80 blocks. Double self tacking car for PBB 100.
- The toggle/sheet block is supported by a rubber stand-up collar.
- End controls with rubber shock absorbers and becketts for control lines.
- Suitable max size of control line is Ø 10 mm.

SYSTEM 42

40'

65'

Seldén system 42 can be used for boats up to approximately 65'. See all combinations at pages 72-77. For more information about dimensioning, see page 102.



Tilt-absorber for genoa cars, see page 76.



1
Main car



2
Double main car



3
Triple main car



4
Genoa car, pinstop



5
Genoa car 2:1



6
Genoa car 4:1



7

Genoa car with becket



8

Self tacking jib car



9

Double self tacking jib car



10

End control



11

End control with cam, port



12

End control with cam, starboard



13

End control cheek



14

End control HD 2:1



15

End control HD 4:1



16

High beam adaptor



17

End stop



18

End cap



19

End stop, heavy duty

SYSTEM 42

	Art. no.	Weight (g)	Safe working load ^{1) 2)} (kg)	Breaking load ²⁾ (kg)	Length (mm)	Width (mm)	Purchase	Combine with...
1	444-181-01	1400	2500	5000	249	98	4:1	PBB 80, RBB 80
2	444-185-02	2735	3000	6000	384	98	4:1	PBB 80, RBB 80
3	444-185-03	2981	3000	6000	384	98	4:1	PBB 80, RBB 80
4	444-151-01	2050	2750	5500	220	69	-	
5	444-190-01	2532	2750	5500	250	96	2:1	
6	444-190-02	2709	2750	5500	250	96	4:1	
7	444-190-03	2490	2750	5500	250	96	-	
8	444-179-01	770	2000	4000	144	98	-	PBB 80, RBB 80
9	444-179-02	1800	4000	8000	294	98	-	PBB 100
10	444-112-01 ³⁾	510	-	-	126	70	4:1	
11	444-112-02 ³⁾	626	-	-	126	100	4:1	
12	444-112-03 ³⁾	626	-	-	126	100	4:1	
13	444-112-04 ³⁾	440	-	-	126	70	2:1	
14	444-148-01	565			144	70	2:1	
15	444-148-02	744			144	70	4:1	
16	444-135	110	-	-	64	70	-	
17	444-138-01 ³⁾	202	-	-	90	70	-	
18	444-127	38	-	-	45	50	-	
19	444-143-01	232	-	-	103	70	-	444-179-02

¹⁾ 70° sheet angle on genoa car. ²⁾ Max working load for end controls are in line with corresponding main sheet car or genoa car. See system pages 72-77. ³⁾ Fasteners not included.



MAIN SYSTEM

22
30
30 PERFORMANCE
42



Operated with cam cleats fitted to the end controls. Suitable for coach roof installations in combination with mid sheeted booms.

MAIN SYSTEM 4:1, WITH CAM CLEAT

Size	End control Art. no.	Main car Art. no.	End control Art. no.
System 22	442-112-02	442-149-01	442-112-03
System 30	443-112-02	443-181-01	443-112-03
System 42	444-112-02	444-181-01	444-112-03



The control line is led to a separate cam cleat or winch.

SYSTEM 22

20' 33'

SYSTEM 30

30' 45'

SYSTEM 42

40' 65'

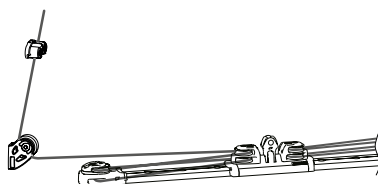

A single lead block fitted to the cockpit side directs the control line to the trimmer, who locks it in a cam cleat. A convenient and common way to handle the traveller on keel boats.

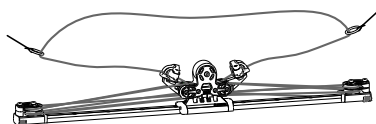

Hint! Let the main sheet control line be endless and lead it through two rings. Each ring is fitted to the rail with rubber cord, each side of the cockpit. This way the leeward end of the control line can be released from windward.

MAIN SYSTEM 4:1

Size	End control Art. no.	Main car Art. no.	End control Art. no.
System 22	442-112-01	442-149-01	442-112-01
System 30	443-112-01	443-181-01	443-112-01
System 42	444-112-01	444-181-01	444-112-01



Lead block and cam cleat to be mounted separately in the cockpit.

MAIN SYSTEM 4:1

Size	End control Art. no.	Main car Art. no.	End control Art. no.*
System 22	442-112-04	442-149-01	442-112-04
System 30	443-112-04	443-181-01	443-112-04
System 42	444-112-04	444-181-01	444-112-04



The cam cleat is angled towards the trimmer and the angle can be fine tuned by using wedges, 433-116-01R and 433-216-01R, see page 86.

MAIN SYSTEM 6:1, CAM CLEAT ON CAR

Size	End control Art. no.	Main car Art. no.	End control Art. no.
System 22	442-112-01	442-149-02	442-112-01
System 30	443-112-01	443-182-01	443-112-01

For a complete system, track and control line must be added.



This system is for German sheeting. Lead block and cam cleat to be mounted separately in the cockpit, see page 72.

MAIN SYSTEM PERFORMANCE 6:1, FIXED BLOCK

Size	End control Art. no.	Main car Art. no.	End control Art. no.
System 30 Performance	443-303-02	443-351-01	443-303-02



The cam cleat is angled towards the trimmer and the angle can be fine tuned by using wedges, 433-216-01R, see page 87. It also has a horizontal adjustment. This makes for excellent ergonomics and helps the trimmer to sail actively for long periods of time. This system is for German sheeting.

MAIN SYSTEM PERFORMANCE 6:1, CAM CLEAT FIXED BLOCK

Size	End control Art. no.	Main car Art. no.	End control Art. no.
System 30 Performance	443-303-02	443-351-02	443-303-02



Lead block and cam cleat to be mounted separately in the cockpit. The toggle is suitable for PBB 60, PBB 70 and RBB 60 blocks.

MAIN SYSTEM PERFORMANCE 6:1

Size	End control Art. no.	Main car Art. no.	End control Art. no.
System 30 Performance	443-303-02	443-351-03	443-303-02



The cam cleat is angled towards the trimmer and the angle can be fine tuned by using wedges, 433-216-01R, see page 87. It also has a horizontal adjustment. This makes for excellent ergonomics and helps the trimmer to sail actively for long periods of time. The toggle is suitable for PBB 60, PBB 70 and RBB 60 blocks. Cam cleats angle adjustment, see page 66.

MAIN SYSTEM PERFORMANCE 6:1, CAM CLEAT TOGGLE

Size	End control Art. no.	Main car Art. no.	End control Art. no.
System 30 Performance	443-303-02	443-351-04	443-303-02



MAIN SYSTEM

30
30 PERFORMANCE
42



Operated with cam cleats fitted to the end controls. Suitable for coach roof installations in combination with mid sheeted booms.

DOUBLE/TRIPLE MAIN SYSTEM 4:1, WITH CAM CLEAT

Size	End control Art. no.	Main car Art. no.	End control Art. no.
System 30	443-112-02	443-185-01	443-112-03
		443-185-02	
System 42	444-112-02	444-185-02	444-112-03
		444-185-03	

SYSTEM 30

30' 45'

SYSTEM 42

40' 65'

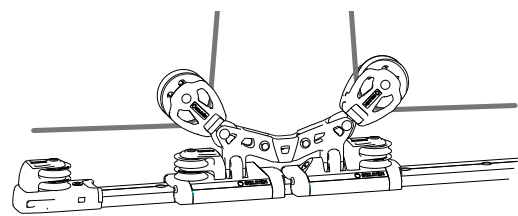

Double main system

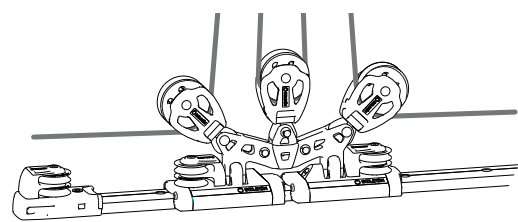

Triple main system



The control line is led to a separate cam cleat.



Lead block and cam cleat to be mounted separately in the cockpit, see page 72.



Lead block and cam cleat to be mounted separately in the cockpit, see page 72.

DOUBLE/TRIPLE MAIN SYSTEM 4:1

Size	End control Art. no.	Main car Art. no.	End control Art. no.
System 30	443-112-01	443-185-01	443-112-01
		443-185-02	
System 42	444-112-01	444-185-02	444-112-01
		444-185-03	

DOUBLE/TRIPLE MAIN SYSTEM 4:1

Size	End control Art. no.	Main car Art. no.	End control Art. no.
System 30	443-112-04	443-185-01	443-112-04
		443-185-02	
System 42	444-112-04	444-185-02	444-112-04
		444-185-03	

DOUBLE MAIN SYSTEM PERFORMANCE 6:1, FIXED BLOCKS

Size	End control Art. no.	Main car Art. no.	End control Art. no.
System 30 Performance	443-303-02	443-351-05	443-303-02



GENOA SYSTEM

22
30
30 PERFORMANCE
42



GENOA SYSTEM PIN STOP, SLIDING RODS

Size	Forward End stop Art. no.	Genoa car Art. no.	Aft End stop Art. no.
System 22	442-105	442-102-01	442-105
		442-150-01*	
System 30	443-125	443-126-01	443-125
		443-167-01	
System 42	444-127	444-151-01	444-127

Pin stop track to be used

* 442-150-01 for 2:1 sheeting. For more information see page 61.

SYSTEM 22

20' 33'

SYSTEM 30

30' 45'

SYSTEM 42

40' 65'

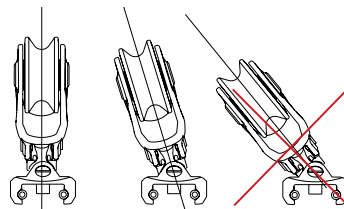

The tilt-absorber prevents the unloaded sheave house to chafe on the coach side.

TILT-ABSORBER FOR GENOA CARS

Art. No.	Description	Includes	Fits cars
443-155-01R	Genoa tilt-absorber	2 x Tilt-absorber (System 30) 4 x Screw M3x4 (System 30 performance) 4 x Screw M4x5 (System 42)	443-167-01 443-190-01, 444-190-01, 444-190-02, 443-350-01,443-350-02, 443-350-03,443-352-01, 444-151-01



GENOA SYSTEM 3:1, SLIDING RODS

Size	Forward End control Art. no.	Genoa car Art. no.	Aft End stop Art. no.
System 22	442-103-01	442-101-01	442-105
System 30	443-124-01	443-117-01	443-125



GENOA SYSTEM 4:1, BALL BEARING

Size	Forward End control Art. no.	Genoa car Art. no.	Aft End stop Art. no.
System 30	443-112-01	443-190-01	443-125
System 42	444-148-02	444-190-02	444-127



GENOA PERFORMANCE SYSTEM 2:1, BALL BEARING

Size	Forward End control Art. no.	Genoa car Art. no.	Aft End stop Art. no.
System 30 Performance	443-303-01	443-350-01	443-125



GENOA PERFORMANCE SYSTEM 4:1, BALL BEARING

Size	Forward End control Art. no.	Genoa car Art. no.	Aft End stop Art. no.
System 30 Performance	443-303-02	443-350-02	443-125



GENOA PERFORMANCE SYSTEM 7:1, BALL BEARING

Size	Forward End control Art. no.	Genoa car Art. no.	Aft End stop Art. no.
System 30 Performance	443-304-02	443-352-01	443-125

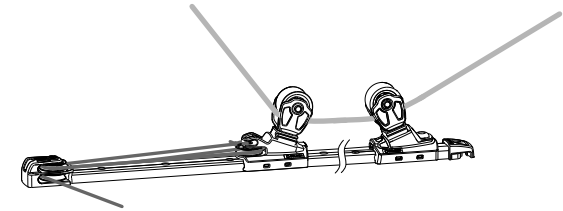

Genoa car and genoa sheet lead car.
The sheet lead car is used to lead the sheet correctly to a winch with a steep angle.
System 30 genoa sheet lead car, 443-126-02, see page 62.

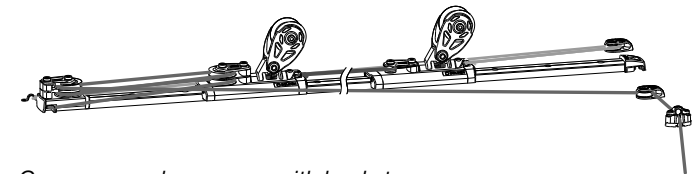

Genoa car and genoa car with becket.
Two cars connected on a long track allow the new sheet to be set and the car correctly positioned before sail changes. A cable or line connects the cars. Genoa car with becket, 443-350-03, connects to all System 30 Performance genoa cars, see page 68.

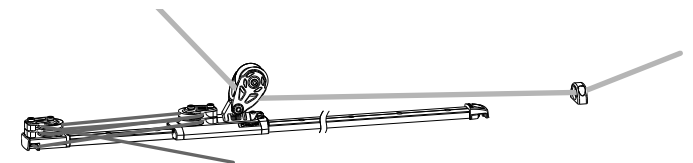

Genoa car + sheet lead.
The sheet lead is used to lead the sheet correctly to a winch with a shallow angle. Sheet lead 442-136/443-136 fits all systems, see page 94.

For a complete system, track and control line must be added.



SELF TACKING JIB SYSTEM

22 30

The ideal combination for convenience and performance - self tacking jib and Code 0.

CUSTOM TRACKS

Seldén provide customized curved tracks in sizes 22, 30 and 42 mm on request. An enquiry form, 595-952-E, is available at www.seldenmast.com.

Ball-joint for adjustment of the track angle and console angle.



Stainless steel AISI 316 side consoles. Can be shortened if needed.

The cars run on Torlon® ball bearings.

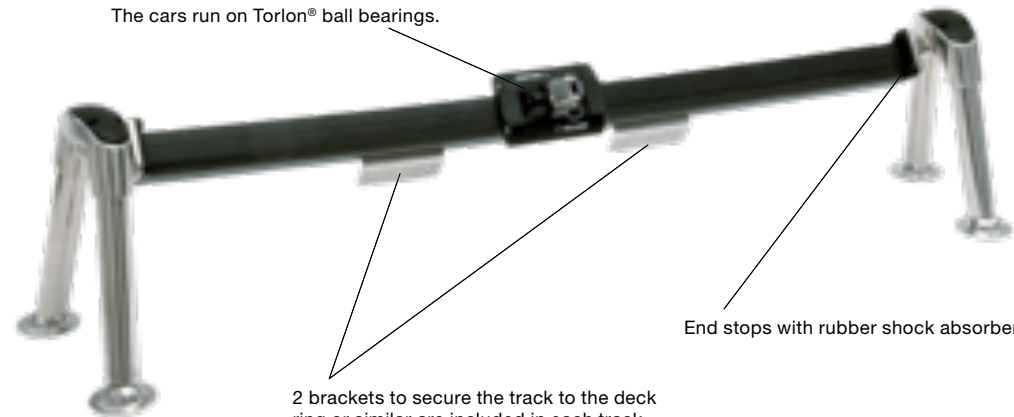

End stops with rubber shock absorbers.

2 brackets to secure the track to the deck ring or similar are included in each track assembly.

SELF TACKING JIB SYSTEMS

A self-tacking jib makes life on board a lot easier, in particular for short handed crews. The jib sheet is led to a car which moves to leeward during the tack with no need to touch the sheet. Tacking is as simple as steering the boat through the wind.

For retro-fit installations on boats ranging from 25' to 45', high beam tracks with a standard radius and standard length can be ordered from stock. The side consoles, deck fittings and a car are added to complete the system. A ball-joint allows for perfect alignment of the track to a 90° angle to the direction of load and for an easy installation to the deck or coach side.

This is how to order a self tacking system:

1. SHEET ARRANGEMENT OPTIONS

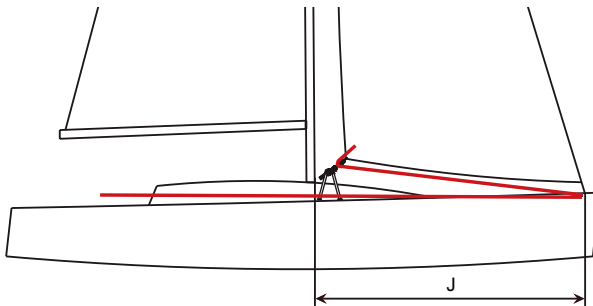

OVER THE FORE DECK

This is the simplest and most common arrangement. The sheet is led from the clew, through a single block on the car, through a block at the bow and back to the cockpit.

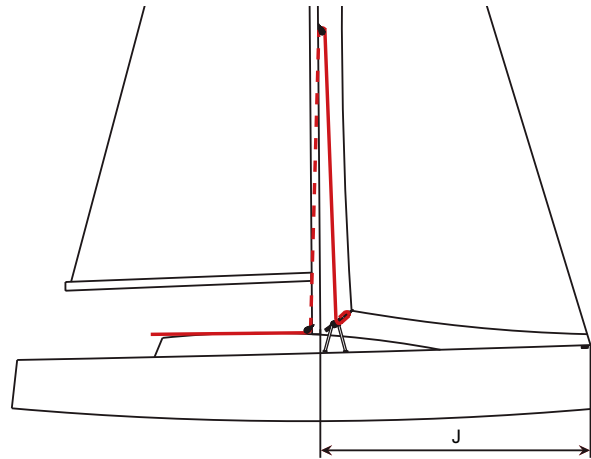

UP THE MAST

The advantage of leading the sheet up through the mast and back to the cockpit is to keep the foredeck clean from lines. It requires a 2:1 purchase on the sheet and consequently a single/bucket block is used on the car. The sheet is led from the car, up the front of the mast and in to the mast through a sheave box installed at a height of 50% of the fore triangle. The sheet exits the mast through a slot fitting and turns through a block at the foot of the mast and back to the cockpit. The deck light and the steaming light on the mast might need to be relocated. Sheet cranes are available for boats fitted with a VPS (Vertical Pole Stowage) system.



Sheet crane

SHEET CRANE

Mast section	Max RM at 30°, kNm	Sheet crane Art.No. Length, mm (L)	Sheet exit box, Art. No.	Min distance between sheet box and crane, mm (H)	Max line size, ø mm
C227-C304 F228-F305	170	508-094-01 L=200	505-016-01	1200	12
C264-C365 F265-F370		508-093-01 L=275	505-015-01	1500	14

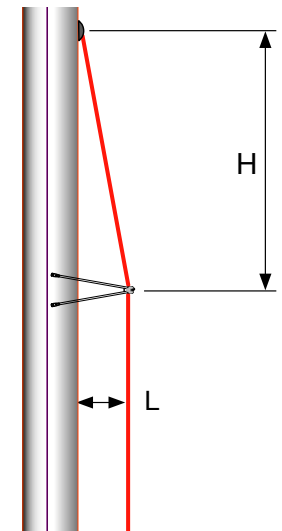

2. SELECT TRACK

System	J-measurement, mm	Art. No.	Description	For sheet arrangement
ST22	-3700	442-011-40	Radius 3000 mm, Length 1700 mm	Over the fore deck
	3700-4700	442-011-41	Radius 4000 mm, Length 1800 mm	
ST30	3700 – 4700	443-011-41	Radius 4000 mm, Length 1800 mm	Up the mast
	4700 – 6000	443-011-42	Radius 5000 mm, Length 2500 mm	
	3400 – 4700	443-011-43	Radius 6500 mm, Length 1800 mm	
	4700 – 6000	443-011-44	Radius 8000 mm, Length 2500 mm	

3. SELECT CAR

System	Righting moment of the boat at a 30° heel angle, kNm	Approximate displacement, ton	Car Art. No.	Description
ST22	<35	<6	442-148-01	Single car
	>35	>6	442-148-02	Double car
ST30	<60	<10	443-139-01	Single car
	>60	>10	443-139-02	Double car

For more information about dimensioning, see page 103.

4. SELECT DECK FITTING

Art. No.	Description
ST22: 442-208-10 ST30: 443-208-10	Deck fitting for a permanent installation on the deck. The fitting articulates and adapts to various deck angles. The system is fixed with a through-bolt from the underside of the deck, through the deck fitting, console and upper bracket.  Parts included: 4 deck fittings 4 washers and nuts
ST22: 442-206-10 ST30: 443-206-10	Fittings for installations to the coach side or deck. Clevis pins connect the consoles to the deck fittings allowing quick removal of the entire system from the boat. Ideal for sailors who occasionally want to optimize their boat for racing by use of overlapping jibs.  Parts included: 4 deck fittings including clevis pins 4 pcs connectors for the consoles.

5. ORDER SIDE CONSOLES

ST22: 442-200-10

ST30: 443-200-10

6. SELECT BLOCK

Single or single/becket depending on sheet arrangement.





COMPLETE SHEET SYSTEMS



COMPLETE SHEET SYSTEMS

	Art. No.	Description	Consists of	Combine with...
1	400-022-01R	Main sheet system 22, 4:1	442-001-03 Track 22, M5, L=1500 mm 442-149-01 Main sheet car 22 442-112-02 End control port/cam 22 442-112-03 End control starboard/cam 22 400-500-09 Control line, black Ø7 L=9200 mm	PBB 50. For BBB 60 and MRB 60 only single, fiddle and becket block
2	400-022-02R	Main sheet system 22 with cam cleat, 6:1	442-001-03 Track 22, M5, L=1500 mm 442-149-02 Main sheet car/cam 22 442-112-01 2 x End control, 22 400-500-12 Control line, black L=12000 mm	
3	400-022-05R	Main sheet system 22 high beam, with cam cleat, 6:1	442-011-03 Track 22, high beam, L=1500 mm 442-149-02 Main sheet car/cam 22 442-112-01 2 x End control, 22 442-135 2 x high beam adaptor 400-500-12 Control line, black L=12000 mm	
4	400-030-01R	Main sheet system 30, 4:1	443-001-03 Track 30, M6, L=1500 mm 443-181-01 Main sheet car 30 443-112-02 End control port/cam 30 443-112-03 End control starboard/cam 30 400-500-09 Control line, black Ø7 L=9200 mm	PBB 60, PBB 70, RBB 60
5	400-030-02R	Main sheet system 30, with cam cleat, 6:1	443-001-03 Track 30, M6, L=1500 mm 443-182-01 Main sheet car/cam 30 443-112-01 2 x End control, 30 400-500-15 Control line, black L=15000 mm	
6	400-030-04R	Main sheet system 30 high beam, 4:1	443-011-03 Track 30, high beam L=1500 mm 443-181-01 Main sheet car 30 443-112-02 End control port/cam 30 443-112-03 End control starboard/cam 30 443-135 2 x high beam adaptor 30 400-500-09 Control line, black Ø7 L=9200 mm	
7	400-030-05R	Main sheet system 30 high beam, with cam cleat, 6:1	443-011-03 Track 30, high beam, L=1500 mm 443-182-01 Main sheet car/cam 30 443-112-01 2 x End control, 30 443-135 2 x high beam adaptor 30 400-500-15 Control line, black L=15000 mm	
8	442-150-13R	Jib car 22 kit	442-004-03 Track 22, Jib car stop, L=500mm 442-150-01 Jib car 22 442-105 End stop	

SYSTEM 22

20' 33'

SYSTEM 30

30' 45'

TACKLES

Using ready made tackles is an easy way to make noticeable improvements to function and looks on board. The line is a grey coloured, 24-plait Polyester line sewed to the block.

1 → 7



8 → 11



12 → 15

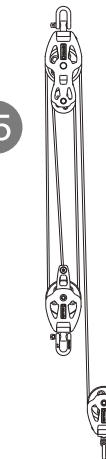

Examples of BBB 60/BBB40 main sheet tackles with fine tuning.

TACKLES 4:1

Cam cleat operated. Can be used as kicker tackle, main sheet, backstay adjustment etc.

Art. No.	Description	Block		Line	
1	Tackle 4:1 BBB40, Cam	404-101-12R 404-101-15R	Fiddle swivel/fixe Fiddle swivel/fixe becket cam	400-503-12	Line, grey Ø7 L=12000 mm
2	Tackle 4:1 BBB40, Cam	404-101-12R 404-101-15R	Fiddle swivel/fixe Fiddle swivel/fixe becket cam	400-503-18	Line, grey Ø7 L=18000 mm
3	Tackle 4:1 PBB50, Cam	405-001-14R 405-001-11R	Fiddle becket cam Fiddle	612-043-110	Line, grey Ø8 L=10000 mm
4	Tackle 4:1 PBB50, Cam	405-001-11R 405-001-14R	Fiddle Fiddle becket cam	612-053-120	Line, grey Ø10 L=20000 mm
5	Tackle 4:1 PBB60, Cam	406-001-14R 406-001-11R	Fiddle becket cam Fiddle	612-053-112	Line, grey Ø10 L=12000 mm
6	Tackle 4:1 PBB60, Cam	406-001-14R 406-001-11R	Fiddle becket cam Fiddle	612-053-120	Line, grey Ø10 L=20000 mm
7	Tackle 4:1 BBB60, Cam	406-601-13R 406-601-10R	Fiddle becket cam Fiddle	612-053-120	Line, grey Ø10 L=20000 mm

TACKLES 6:1

Cam cleat operated. Can be used as kicker tackle, main sheet, backstay adjustment etc.

Art. No.	Description	Block		Line	
8	Tackle 6:1 BBB40, Cam	404-101-08R 404-101-11R	Triple swivel Triple swivel becket cam	400-503-18	Line, grey Ø7 L=18000 mm
9	Tackle 6:1 PBB50, Cam	405-001-07R 405-001-10R	Triple Triple becket cam	612-053-130	Line, grey Ø10 L=30000 mm
10	Tackle 6:1 PBB60, Cam	406-001-07R 406-001-10R	Triple Triple becket cam	612-053-130	Line, grey Ø10 L=30000 mm
11	Tackle 6:1 BBB60, Cam	406-601-06R 406-601-09R	Triple Triple becket cam	612-053-130	Line, grey Ø10 L=30000 mm

TACKLES 4:1

Operation from the cockpit

Art. No.	Description	Block		Line	
12	Tackle 4:1 BBB40, Kick/aft	404-101-03R 404-101-12R 404-101-01R	Single swivel/fixe becket Fiddle swivel/fixe Single swivel/fixe	400-503-12	Line, grey Ø7 L=12000 mm
13	Tackle 4:1 PBB50, Kick/aft	405-001-02R 405-001-11R 405-001-01	Single becket Fiddle Single	612-043-110	Line, grey Ø8 L=10000 mm
14	Tackle 4:1 PBB60, Kick/aft	405-001-02R 406-001-11R 405-001-01R	Single becket Fiddle Single	612-053-112	Line, grey Ø10 L=12000 mm
15	Tackle 4:1 BBB60, Kick/aft	406-601-02R 406-601-10R 406-601-01R	Single becket Fiddle Single	612-043-110	Line, grey Ø8 L=10000 mm

CLEATS & SWIVELS



Cam cleat,
pages 86-87



Valley cleat,
pages 88-89



Swivels,
pages 90-91



CLEATS

Seldén produces Cam cleats in two sizes, together with all necessary accessories for efficient line handling. Valley cleats are also available in various sizes and for a wealth of different functions.

SWIVELS

The swivel range comprises deck swivels, mast swivels and eye swivels. The eye swivel features a unique combination of plain bearing (to obtain optimal friction reduction) and ball bearing (to improve stability).

The ten-step adjustment of the deck swivel is also unique, as are the horizontal angle adjustment and friction adjustment features.



Cam cleats with fairleads.



Eye swivel



Composite arm

Stainless steel eye

Composite Cam cleat 27

Stop screws

Stainless steel ball bearings





CAM CLEATS 27/38



CAM CLEATS

Seldén Cam cleats are made of carbon fibre reinforced polymer. This material is selected for its high resistance to friction heat. There is also an aluminium version of Cam cleat 38 available.

1



Cam cleat 27/38 Composite
Cam cleat 38 Aluminium

2



Top Guide 27/38

3



Fair lead 27/38

4



Riser 27/38

5



Wedge Kit 27/38

6



Nut Recess 27/38

7



Bull's Eye 27/38

8



Line Guide 27/38

9



Curved Base 27/38

10



2-P Eye



Cam cleat with top guide.



Cam cleat with fair lead.



Eye swivel.



Cam cleat & bull's eye.

CAM CLEAT 27

Rope capacity 3-7 mm.
Hole spacing c-c 27 mm. Fasteners M4.

	Art. No.	Weight (g)	Safe working load (kg)
1	433-101-01R	15	90
2	433-108-01R	3	-
3	433-110-01R	14	-
4	433-115R	9	-
5	433-116-01R	5	-
6	433-118R	3	-
7	433-119-01R	6	-
8	433-113-01R	4	-
9	319-844	1	-

CAM CLEAT 38

Rope capacity 4-12 mm.
Hole spacing c-c 38 mm. Fasteners M5.

	Art. No.	Weight (g)	Safe working load (kg)
1	433-201-01R	32	120
1	433-301-01R	57	180
2	433-208-01R	9	-
3	433-210-01R	37	-
4	433-215R	21	-
5	433-216-01R	15	-
6	433-414R	5	-
7	433-219-01R	16	-
8	433-213-01R	11	-
9	319-823	3	-
10	508-019	14	-



VALLEY CLEATS

VALLEY CLEATS

This type of cleat is available in several versions for many different applications. Countersunk head bolts of the recommended size should be used.

The polymer cleat is ideal for low load applications whereas the aluminium cleats prevent rope burn under higher load.

Seldén Valley cleats are designed and produced by Clamcleat Ltd, UK.



<p>1</p>  <p>Standard (201) PA</p>	<p>2</p>  <p>Standard (222) AL</p>	<p>3</p>  <p>Fairlead (211 Mk1) AL</p>
<p>4</p>  <p>Fairlead (211 Mk2) AL</p>	<p>5</p>  <p>Fairlead. End of rope can be fixed under the cleat (270) AL</p>	<p>6</p>  <p>Rope entry from starboard (217 Mk1) AL</p>
<p>7</p>  <p>Rope entry from port (218 Mk1) AL</p>	<p>8</p>  <p>Rope entry from port (218 Mk2) AL</p>	<p>9</p>  <p>Roller for lines coming from above (236) AL</p>
<p>10</p>  <p>Roller for lines coming from below (230) AL</p>	<p>11</p>  <p>Quick lock and release function for trapeze or vang (253) AL</p>	<p>12</p>  <p>Fine line application in sail, starboard (258) AL</p>

13



Fine line application in sail, port (259) AL

14



Standard (254) AL

15



Fairlead (211 Mk2S2) AL

16



Fairlead (268) AL

17



Fairlead. End of rope can be fixed under the cleat (704) AL

18



Tapered pad. Aids rope alignment for 432-014, 432-025 (823) PA

19



Tapered pad. Aids rope alignment for 432-011 (802) PA

20



Tapered pad. Aids rope alignment for 432-013, 432-024, 432-017(819) PA

21



Tapered pad. Aids rope alignment for 432-023 PA

22



Tapered pad. Aids rope alignment for 432-012, 432-015, 432-016, 432-018, 432-026 (818) PA

23



Sail Line Starboard (CL241) AL

24



Sail Line Port (CL273) AL

VALLEY CLEAT

	Art. No.	Weight (g)	Rope capacity (mm)	Bolt	Hole spacing C-C, (mm)
1	432-010R	43	6-12	M6	72
2	432-011R	16	1-6	M4	36
3	432-012R	35	1-6	M5	66
4	432-013R	23	1-6	M4	27
5	432-014R	13	1-6	M3	24
6	432-015R	30	1-6	M5	66
7	432-016R	30	1-6	M5	66
8	432-017R	24	1-6	M4	27
9	432-018R	40	1-6	M5	66
10	432-019R	35	1-6	M5	66
11	432-020R	46	4-8	-	70
12	432-021R	19	3-6	M4	49
13	432-022R	19	3-6	M4	49
14	432-023R	38	4-8	M5	55
15	432-024R	21	1-6	M4	27
16	432-025R	11	1-6	M3	24
17	432-026R	34	1-6	M5	66
18	432-027R	4	-	M3	24
19	432-028R	4	-	M4	36
20	432-029R	8	-	M4	27
21	432-030R	8	-	M5	55
22	432-031R	14	-	M5	66
23	432-033R	16	3-6	M4	49
24	432-034R	16	3-6	M4	49



DECK SWIVEL 38

EYE SWIVEL 27/38

MAST SWIVEL 27/38



Deck Swivel 38



2 Eye Swivel 27
3 Eye Swivel 38

SWIVELS

Seldén provide three types of swivels
– deck swivel, mast swivel and eye swivel.



EYE SWIVEL

The eye swivel is designed for control lines close to the deck, as with dinghy jib sheets. The swivel can also be used on bigger boats if the purchase of the tackle is sufficient. One eye swivel on each side of the coach roof is an ideal set-up for the vang. The crew on the rail can easily reach the vang to prevent a broach. The angle of articulation is easily adjusted with two screws. The swivel turns on stainless steel ball bearings for durability. The eye swivel is made of glass fibre filled polymer with an electro polished, stainless steel line guide.



Mast Swivel 27



Mast Swivel 38

DECK SWIVEL

The deck swivel articulates to follow the movements of the trimmer. Used for main sheets on keelboats and smaller yachts. Can also be used on bigger boats if the purchase of the tackle is sufficient. The materials used are composite and stainless steel. Recommended blocks are MRB60, PBB50 and PBB60. The block, without shackle, fits on the stainless steel axle.

Horizontal articulation. The angle of horizontal movement is easily adjusted without taking the swivel apart. Two stops can be fixed in 5 different positions, from a fixed arm to 300° angle of movement.



Horizontal friction. The amount of friction for horizontal movement is adjusted with a control knob. The knob is located in a recess in order to prevent accidental adjustment, but is still easy to reach with a screwdriver or similar tool.

Vertical articulation is easily adjusted from a flat horizontal lead to

a steep 45° angle.



MAST SWIVEL

The mast swivel leads the line with full articulation towards the trimmer. The swivel is made of glass fibre reinforced composite. It is mainly used for Cunningham, Spinnaker and Gnav etc. The sheave has two optional positions, either for lines coming from above or from below. The mast swivel can be fitted “up-side-down” depending on desired orientation of the Cam cleat. The sheave is of ball bearing type.



SWIVELS

	Art. No.	Weight (g)	Safe working load (kg)	Max line size (mm)
1	433-401-01R	362	120	12
2	433-611-01R	113	90	7
3	433-611-02R	166	120	12
4	433-501-01R	104	90	7
5	433-501-02R	126	120	8



DECK ORGANIZER 40/50

DECK ORGANIZER

Seldén deck organizers keep the deck tidy and lead the ropes back to the cockpit. The polymer sheaves have polymer ball bearings absorbing side loads from a rope entering the organizer with a vertical angle. The result is low friction making hoisting and trimming of sails fast and easy. The organizers can be fitted to a slightly curved surface and two organizers can be stacked on top of each other. The deck organizers are made of glass fibre reinforced polymer.



- 1 6



DECK ORGANIZER
2 sheaves
- 2 7



DECK ORGANIZER
3 sheaves
- 3 8



DECK ORGANIZER
4 sheaves
- 4 9



DECK ORGANIZER
5 sheaves
- 5 10



DECK ORGANIZER
6 sheaves

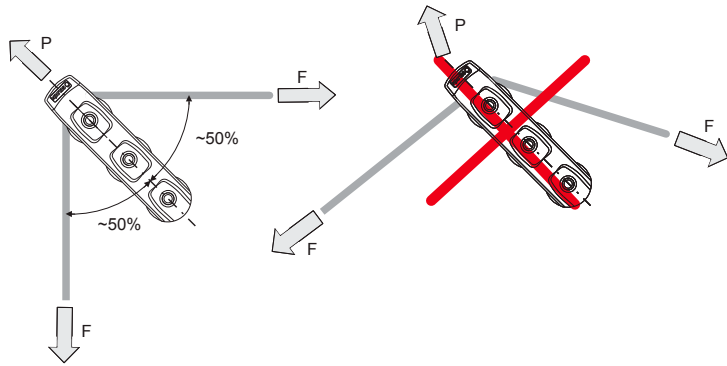

Fit the organizers so that they align with the direction of the total load.
For more information, see page 100.

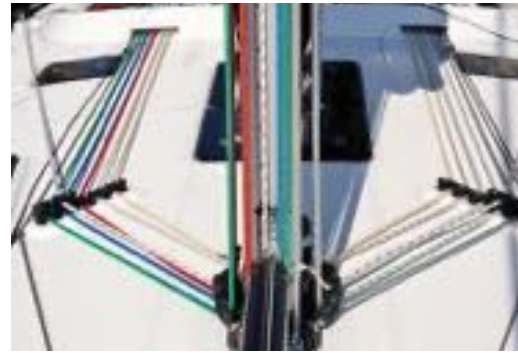

Two organizers can be stacked on top of each other.
Safe working load is stated at 90° angles. Safe working load and breaking load is reduced 50% for an organizer stacked on top of another.



Ball bearing sheaves absorbing side loads.

For hole patterns, see page 109.

DECK ORGANIZERS Ø 40 mm

Hole spacing c-c 47 mm

	Art. No.	Description	Weight (g)	Safe working load* (kg)	Breaking load* (kg)	Max line size (mm)	Fasteners
1	420-001-02R	2 sheaves	100	700	1400	14	2xM6
2	420-001-03R	3 sheaves	154	700	1400	14	3xM6
3	420-001-04R	4 sheaves	194	700	1400	14	4xM6
4	420-001-05R	5 sheaves	238	700	1400	14	5xM6
5	420-001-06R	6 sheaves	292	700	1400	14	6xM6

Safe working load is stated at 90° angles.

* Safe working load and breaking load is reduced 50% for an organizer stacked on top of another.

DECK ORGANIZERS Ø 50 mm

Hole spacing c-c 58 mm

	Art. No.	Description	Weight (g)	Safe working load* (kg)	Breaking load* (kg)	Max line size (mm)	Fasteners
6	420-101-02R	2 sheaves	172	1000	2000	16	2xM8
7	420-101-03R	3 sheaves	258	1000	2000	16	3xM8
8	420-101-04R	4 sheaves	340	1000	2000	16	4xM8
9	420-101-05R	5 sheaves	420	1000	2000	16	5xM8
10	420-101-06R	6 sheaves	510	1000	2000	16	6xM8

* Safe working load and breaking load is reduced 50% for an organizer stacked on top of another.

COMPLEMENTARY HARD WARE

SWIVEL LOCK

An insert is used to locate the shackle at 0° or 90°. When removed the shackle spins freely. Used for PBB 40, BBB 30, BBB 40, BBB 60, ARB 45 and MRB 60.

SWIVEL LOCK

- 1
- 2
- 3
- 4
- 5

Art. No.	Dimension	Weight (g)	Combine with...
403-131R	20x16x7	1	BBB 30, Single/Fiddle
404-131R	26x18x5	1	BBB 40, Single/Fiddle, ARB 45 Single/Fiddle
406-610R	33x19x6	2	BBB 60, Single/Fiddle, MRB 60 Single/Fiddle
406-611R	30x22x10	2	BBB 60, Double/Triple, MRB 60 Triple
404-006R	23x20,5x7,3	2	PBB 40

SHEET LEAD

Machined and black anodised sheet lead designed to lead lines over deck or to achieve correct angle to a winch. The smooth finish of this sheet lead gives minimal friction, allowing it to replace blocks in some applications. Works well as a lead on the windward spinnaker guy on boats up to 35'.

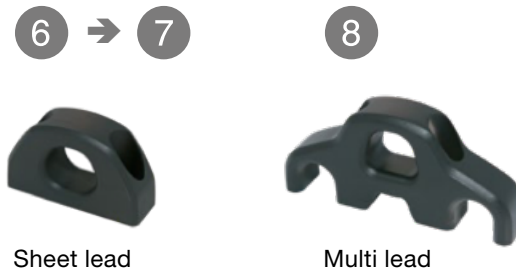

SHEET LEAD

Machined aluminium

- 6
- 7
- 8

Art. No.	Dimension	Weight (g)	Safe working load (kg)	Breaking load (kg)	Max line size (mm)	Bolts
442-136R	c-c 35	23	700	1400	10	2xM6
443-136R	c-c 40	56	1100	2200	12	2xM8
443-162R	c-c 40	103	1100	2200	8/12	2xM8

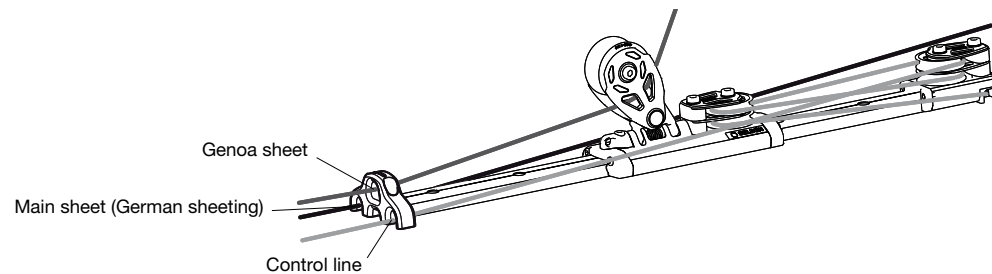

FAIRLEAD

Polymer

- 9
- 10
- 11
- 12
- 13
- 14
- 15
- 16

Art. No.	Dimension	Weight (g)	Max line size (mm)	c-c (mm)
508-600R	25x10	1	5	15
508-601R	38x15	5	8	23
508-603R	25x10	4	5	15
508-604R	39x15	12	10	25
508-605R	52x20	30	14	34
508-609R	25x10	1	3	15
508-610R	25x10	3	4	15
508-611R	38x15	8	8	23

- 9 → 10

- 11 → 13

- 14

- 15 → 16





This block is used for 2:1 purchase for a Code 0 or main halyard.
The pin is captive. No risk dropping it over board.

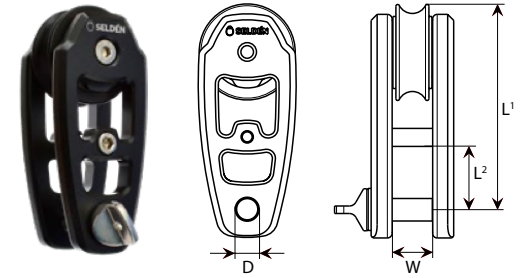

BLOCK FOR 2:1 PURCHASE

Art. No.	Dim.	Weight (g)	L ¹	L ²	W	D	Safe working load (kg)	Breaking load (kg)	Max line size (mm)	Combine with...
403-501-01R	30	100	68	21	13	8	1500	3000	10	CX15
404-501-01R	40	187	85	26	18	10	2500	5000	12	CX25, GX25
405-501-01R	50	335	104	31	24	12	4000	8000	16	CX45

1 4 → 8



2 → 3

9 → 10



FORGED SHACKLES

Stainless AISI 316, Duplex (307-004R)

	Art. No.	Dimension	Weight (g)	Safe working load (kg)	Breaking load (kg)	Combine with...
1	307-004R	Ø12x24x41	186	4000	8000	PBB 100
2	307-026R	Ø8x16x35	56	1500	3000	PBB 70 RBB 60
3	307-027R	Ø10x19x41	126	2000	4000	PBB 80
4	307-080R	Ø4	8	250	500	BBB 30 BBB 40
5	307-081R	Ø5	16	650	1300	PBB 50, BBB 40* BBB 60**, MRB 60**
6	307-085R	Ø8/10	76	2000	4000	PBB 80 RBB 80
7	307-086R	Ø6	26	1000	2000	PBB 60 BBB 60**, MRB 60**
8	307-097R	Ø6/8	40	1500	3000	PBB 70 RBB 60
9	307-098R	Ø5x11x26	18	700	1400	PBB 50
10	307-099R	Ø6x12x33	32	1100	2200	PBB 60

Max working load/breaking load are valid when the shackle is fitted to appropriate Seldén block. *Only used on BBB 40 triple. **Only used on BBB 60/MRB 60 double/triple.

SHACKLES



1 → 5



SNAP SHACKLE ADAPTOR

6 → 9



LOW FRICTION SHACKLE

10



HALYARD SHACKLE

11



DOUBLE SNAP LEAD SHACKLE

SNAP SHACKLE ADAPTORS/ LOW FRICTION SHACKLES

Duplex 2205 stainless

Art. No.	Dim.	Weight (g)	Safe working load (kg)	Breaking load (kg)	Combine with...
1	40	25	550	1100	BBB 40
2	50	60	700	1400	PBB 50, BBB 60 single/fiddle, CX10, GX7,5, GX10
3	60	96	1500	2600	PBB 60, PBB 70, BBB 60 double/triple, RBB 60, CX15, GX15,
4	80	232	2500	5000	PBB 80, RBB 80, CX25, GX25
5	100	490	4500	9000	PBB 100, CX45
6	50	70	700	1400	PBB 50, BBB 60 single/fiddle, CX10, GX7,5, GX10
7	60	118	1500	2600	PBB 60, PBB 70, BBB 60 double/triple, RBB 60, CX15, GX15
8	80	278	2500	5000	PBB 80, RBB 80, CX25, GX25
9	100	540	4500	9000	PBB 100, CX45
10	60	126	1400	2800	Halyard shackle
11	60	220	1500	2600	For hauling out a jib sheet off the wind, and other temporary line routings.

SNAP SHACKLE ADAPTOR

A brilliant solution for any application you want to attach and remove quickly, for example runners and check stays. Just replace the standard shackle with a snap shackle.

LOW FRICTION SHACKLE

This new snap shackle has a big, well rounded loop allowing the rope to slide with low friction. Compared to a regular snatch block, this shackle is lighter, easier to operate and lower cost. Typical applications are barber haulers for spinnaker and jibs but also to tension a Seldén CX with 2:1 purchase. This not only makes for better performance but it also makes it easier to connect the Seldén CX to a bowsprit, from the foredeck. The shackle is made of high strength Duplex steel and has high quality mirror finish.



Low friction shackle for barber hauler and 2:1 purchase

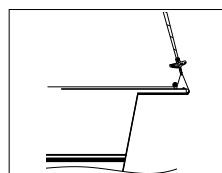
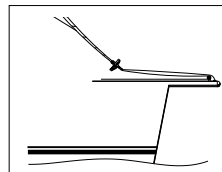

1 → 3



SOFT SHACKLES

For attachment of our "Tie-on" blocks and for attaching a genoa to Furllex jib furling system (4th generation).

Art. No.	Description	Breaking load (kg)	Combine with...
1	SOFT SHACKLE ø5(ropes3) L=85 mm	500	BBB 30 and BBB 40 tie-on. Furllex 104S
2	SOFT SHACKLE ø6(ropes4) L=100 mm	1000	BBB 60 tie-on. Furllex 204S & 304S
3	SOFT SHACKLE ø8(ropes5) L=150 mm	1500	Furllex 404S

MAINLY FOR DINGHIES

	Art. No.	Description	To be used for...	Comments
1	307-421	S hook twisted, L=54 mm	Cunningham, jib halyard	
2	307-451	Hook adaptor for block	PBB 50	
3	307-452	Rig tension hook, high load BBB 25	Jib halyard purchase systems	
4	480-573	Toe strap plate. 51x16 mm		c-c 28,5 mm
5	480-029	Chafe guard, L=130 mm	Prevents chafe on boat and lines	M4
6	480-052	Chafe guard, L=35 mm		M4
7	480-229	Keel band, L=1240 mm	Protects the bow when pulling the boat up the slipway or trolley	M4
8	480-042	Toe strap fitting for 40-50 mm webbing		M5
9	480-363	Webbing bridge for 20-25 mm webbing		M5
10	480-351	"Dead end" for max 6 mm line	To fix the end of a bridle or a cascade	M5
11	319-792	Angled through deck fitting	Leads line through deck	M5
12	508-381	U-bolt, M6 x 98 mm	Shroud attachments	M6
13	174-208-01	Shroud adjuster ø5 mm for fine tuning, 4 mm between each position.	Shroud adjustment	
14	174-221-01	Shroud adjuster ø5 mm. 8 mm between each position.		
15	174-219-01	Shroud adjuster ø6 mm. 12 mm between each position. For up to 18' catamarans.		
16	480-284	Hatch, ø100 mm		
17	480-285	Hatch, ø125 mm		
18	480-286	Hatch, ø150 mm		
19	480-379	Tiller extension, aluminium, 350 mm foam grip.	General purpose dinghies	1100 mm
20	480-060			900 mm
21	480-021			700 mm
22	480-075			Optimist 650 mm



COMPLEMENTARY HARDWARE

Forged and electro polished fittings to attach tackles, cascades, halyard blocks and plenty of other items.



EYE BOLTS

Art. No.	Dimension, bolt Ø x L (mm)	Weight (g)	Safe working load (kg)	Breaking load (kg)	Combine with...	
					Block	Stand up spring
1 508-348	M8x14	32	500	1000	BBB 40 PBB 50	
2 508-357-01R	M8x67	35	500	1000	BBB 40 PBB 50	-
3 508-352-01R	M10x112	112	1000	2000	PBB 50 PBB 60	308-074R

FIXED PAD EYES

Stainless AISI 316

Art. No.	Dimension	Weight (g)	Safe working load (kg)*	Breaking load (kg)	Fasteners	Combine with...	
						Block	Stand-up spring
4 508-815R	Ø50	74	1000	2000	2xM6	PBB 50 BBB 60 MRB 60	308-074R
5 508-816R	Ø60	154	2000	4000	4xM6	PBB 60 PBB 70 RBB 60	308-085R
6 508-817R	Ø72	248	3000	6000	4xM8	PBB 80	308-093R
7 508-818R	Ø86	460	4000	8000	4xM10	PBB 100	308-095R
8 508-347R	40x35	52	700	1400	4xM5	BBB 40 PBB 50	308-074R

*When the padeye is aligned with direction of load.

STAND-UP SPRINGS

Stainless AISI 316



Art. No.	Dimension	Weight (g)	Combine with...
9 308-074R	Ø36.5x70	19	PBB 50 BBB 60 MRB 60
10 308-085R	Ø50x85	49	PBB 60 PBB 70 RBB 60
11 308-093R	Ø60x100	76	PBB 80 RBB 80
12 308-095R	Ø72x145	153	PBB 100
13 403-123R	Ø20/16-25	2	BBB 20 BBB 30
14 433-411R	Ø30/20-40	2	BBB 40

When supported by a stand-up spring, a deck mounted block is always ready for action.

For hole patterns, see page 109.



FOLDABLE PAD EYES

Stainless AISI 316

Art. No.	Dimension	Weight (g)	Safe working load (kg)	Breaking load (kg)	Bolts
15 508-750-01R	Ø6/42x42	74	1100	2200	3xM6
16 508-760-01R	Ø8/54x54	154	2200	4400	3xM8

These foldable pad eyes are used to attach life lines, stay sail furlers, blocks for down haul and barber haulers just to give a few examples. To be able to fold down the eye when not in use is a blessing for bare feet crew members.

"Barber hauling" the jib means you pull the clew to windward. Fixing the line in a pad eye abaft the mast makes for a 2:1 purchase and by leading the line to windward, an efficient and easy accessible trim device is obtained. A rubber cord fitted from the low friction ring to the shroud prevents an unloaded ring to chafe on the coach side.

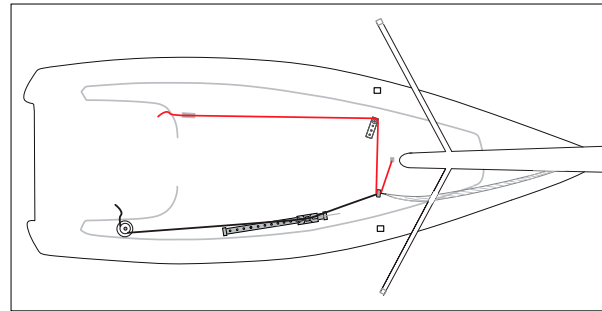

Jib barber hauler.



One ring used for gennaker sheet and Code 0 sheet.

LOW FRICTION RINGS

A low friction ring is a simpler and lighter alternative to a plain bearing block. They are produced in black anodised aluminium and feature a big inner radius for low friction and an outer slot for attachment of a line or rubber cord. Suitable applications are backstay cascades, barber haulers, kicker tackles or any other application with static load.



LOW FRICTION RINGS

Art. No.	Dimensions Outer/Inner, (mm)	Weight (g)	Safe working load (kg)	Breaking load (kg)	Max line size (mm)
1	Ø 12/5	1	150	300	3
2	Ø 18/8	2	350	700	5
3	Ø 25/11	6	750	1500	7
4	Ø 35/16	12	1500	3000	10
5	Ø 50/22	47	3000	6000	14
6	Ø 70/30	108	6000	12000	20

DOUBLE FAIRLEAD

As gennaker furlers are always handled with an endless furling line, spliced together in a continuous loop, ordinary blocks cannot be used to lead the line back to the cockpit. Seldén Double Fairlead consist of a composite bracket fitted to a 25 mm or 30 mm stanchion and a spring loaded "push-and-twist" bracket in stainless steel. Easy to open to attach the line and just as easy to close. The Double Fairlead prevents the line to get tangled up and the smooth stainless bracket prevents friction. **Art. no. 480-501-01R.**

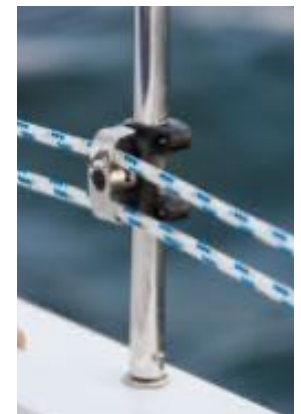

LOADS

PURCHASE SYSTEMS

A tackle is used to increase the effect of human force required for a specific situation and can be designed in several ways.

BREAKING LOADS AND SAFE WORKING LOADS

Breaking loads

Our definition of a breaking load is that load which causes any part of a product to break when it is subjected to successively increasing loads during laboratory testing.

Safe working loads

Our definition of safe working load is set at half the breaking load. We guarantee that products subjected to loads that are below or up to this limit will function satisfactorily.

Loads in the specification tables

The breaking load and safe working load values shown in the product tables are for the product itself (not for the line). The load exerted on the product depends on the load in the line and on the deflection angle of the lines around the sheave.

6:1 purchase with triple blocks.

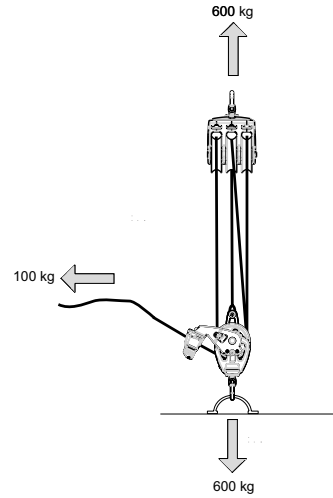

4:1 purchase with fiddle blocks.

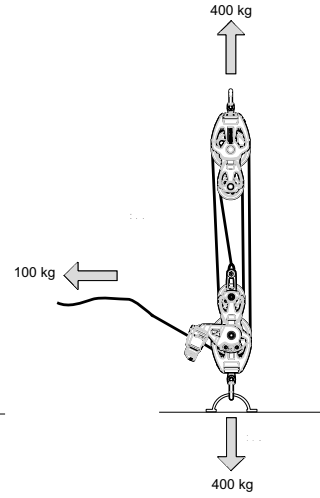

Backstay cascade arrangement based on single blocks. The breaking load (BL) of the upper block must correspond to the BL of the backstay, while the BL requirement is halved step by step for the remaining blocks, cascade legs and final tackle. Low friction rings can be used as an alternative to blocks.

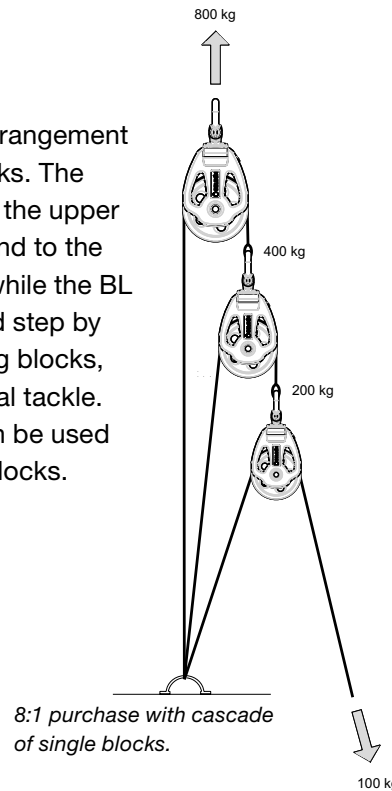

8:1 purchase with cascade of single blocks.

ANGLES The deflection angle must be the same on both sides to guarantee safe working load.

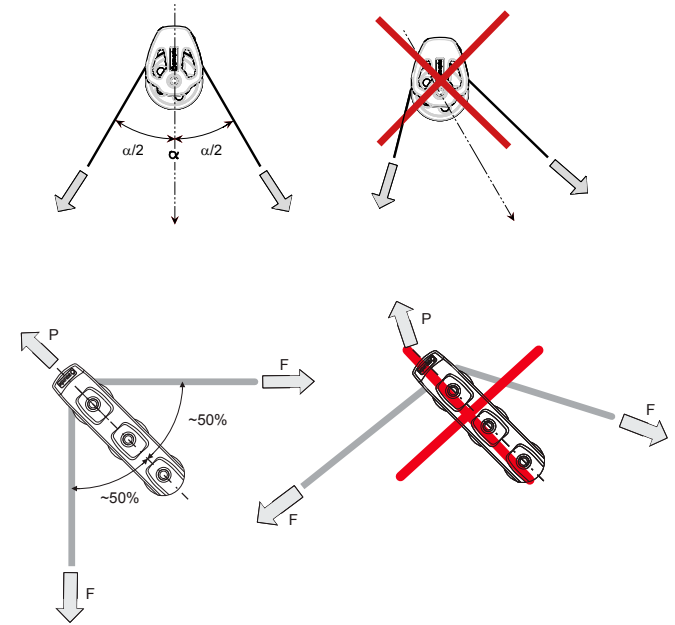

WIRE BREAKING LOAD, Kg

Dimension, ø mm	1 x 19 wire	7 x 19 wire	Compact wire (Dyform)
2	340	210	---
2,5	540	330	---
3	800	510	1000
4	1400	910	1800
5	2200	1420	2500
6	3100	2040	3600
7	4300	2780	4900
8	5600	3630	6200
10	8800	5200	9800
12	12600	---	14400

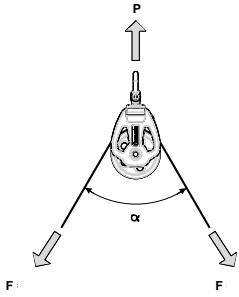

FOLLOW THE LINE

The load (P) exerted on a product depends on the load in the line (F) and on the deflection angle (α) of the line around the sheave.

$$P = k \times F$$

P = the load on the block

k = load factor

F = the load in the line

This applies to blocks, organizers and travellers.

CHOOSING THE RIGHT BLOCK, EXAMPLE:

Assume a halyard load of 800 kg.

While the load in the line remains constant over its entire length, the load on the sheaves depends on the individual deflection angle.

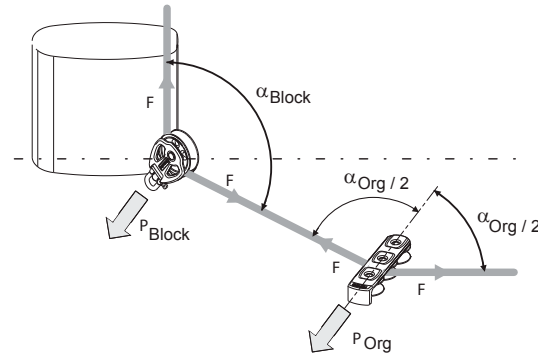

Mast base block

F = 800 kg

$$\alpha_{\text{block}} = 90^\circ \Rightarrow k = 1.41$$

$$P_{\text{block}} = k \times F = 1.41 \times 800 = 1128 \text{ kg}$$

Deck organizer

F = 800 kg

$$\alpha_{\text{org}} = 140^\circ \Rightarrow k = 0.68$$

$$P_{\text{org}} = k \times F = 0.68 \times 800 = 544 \text{ kg}$$

The block is exposed to a load of 1128 kg which means a PBB 70 or RBB 60 will do the job. The deck organizer is exposed to a load of 544 kg which makes us choose the deck organizer size 40.

The selection of block in this example is based on strength requirement only. Wear and friction is not taken into consideration. Therefore a bigger size can sometimes be preferable, see dimensioning guidelines for your application.

CALCULATED LOAD ON A GENOA CAR, EXAMPLE:

Safe working load for a Seldén genoa car is calculated with sheet angle of 70°, equal to a deflection angle of 110°.

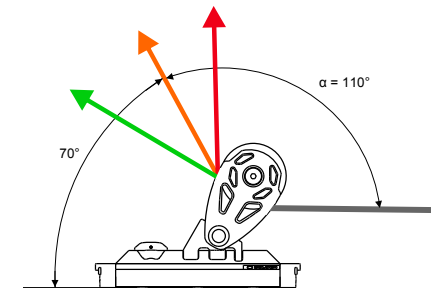

A high performance #3 Genoa might have a sheet angle up to 90°, which gives a deflection angle of 90°.

Example

Assume a sheet load of 1000 kg and deflection angle 90°.

F = 1000 kg

$$\alpha = 90^\circ \quad \alpha_{\#3 \text{ Genoa}} = 110^\circ \Rightarrow k = 1.41/1.15$$

$$P_{\text{car}} = k \times F = 1.41/1.15 \times 1000 = 1226 \text{ kg}$$

Load on the traveller in this example will be 1226 kg.

α [°]	k
0	2,00
10	1,99
20	1,97
30	1,93
40	1,88
50	1,81
60	1,73
70	1,64
80	1,53
90	1,41
100	1,29
110	1,15
120	1,00
130	0,85
140	0,68
150	0,52
160	0,35
170	0,17
180	0

DIMENSIONING

The guidelines are based on strength, function, wear and friction for yachts up to RM=160 kNm (approx 55 feet). For larger yachts please contact your Seldén dealer.

To select the correct block, traveller and track you need to know:

- E=foot length of the main sail.
- S=distance from aft side of the mast to the sheet attachment.
- If your boom is end sheeted or mid sheeted, i.e. the relation between E and S.
- The righting moment at 30° heel angle (RM 30°). If righting moment is not available an approximation can be made from displacement (tonnes) or boat length (feet).

RM 30° (kNm)	Displ. (tonnes)
6	1.2
8	1.6
10	2.0
12	2.4
14	2.8
16	3.2
18	3.6
20	4.0
25	5.0
30	5.7
35	6.3
40	7.0
45	7.7
50	8.2
55	9.0
60	10
70	11
80	12
90	14
100	15
110	16
120	18
130	19
140	20
150	22
160	23

MAIN SHEET BLOCK, END SHEETED BOOM (S>90% of E)

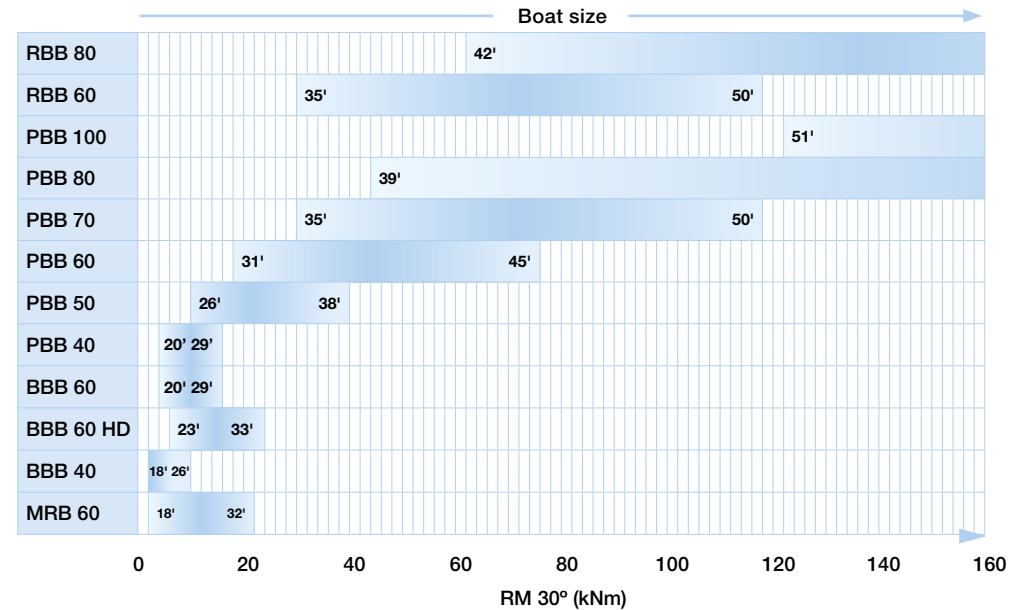

MAIN SHEET BLOCK, MID SHEETED BOOM (S>50% of E)

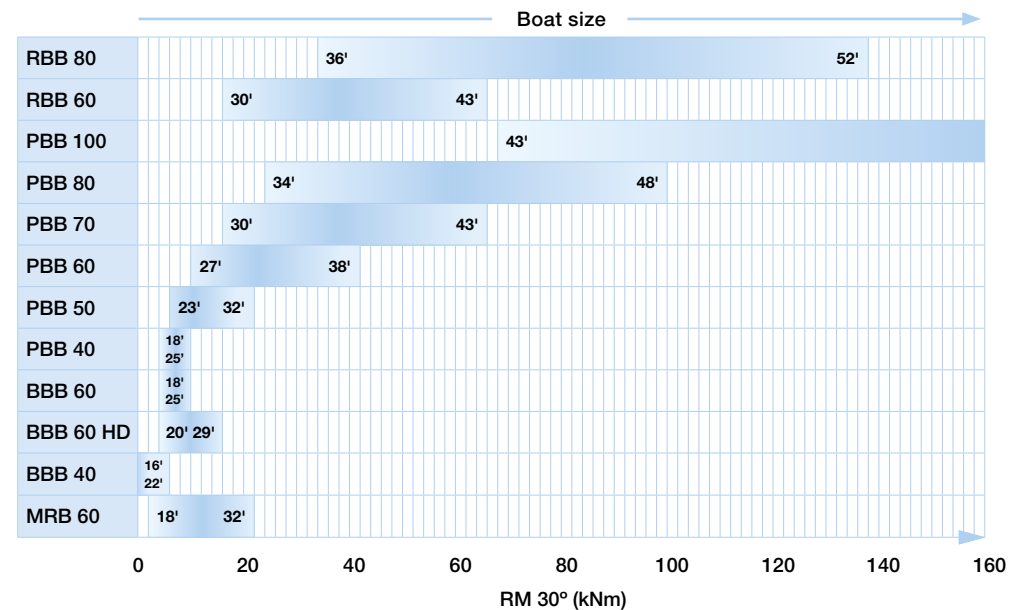

MAIN SHEET CAR, END SHEETED BOOM (S>0,9*E)

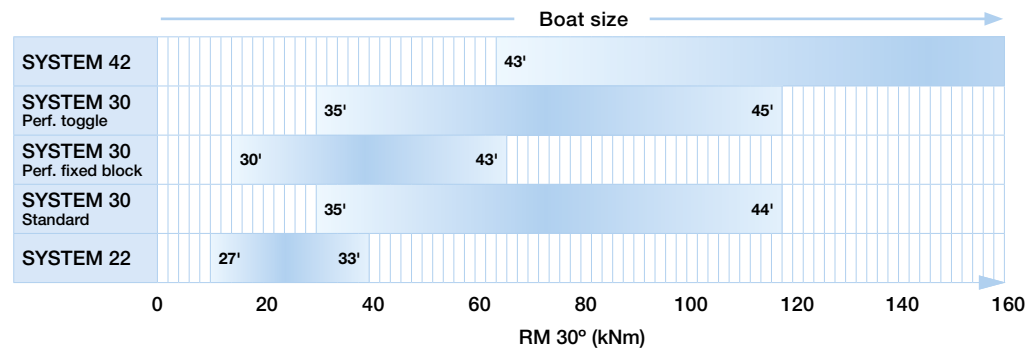

SELF TACKING CAR

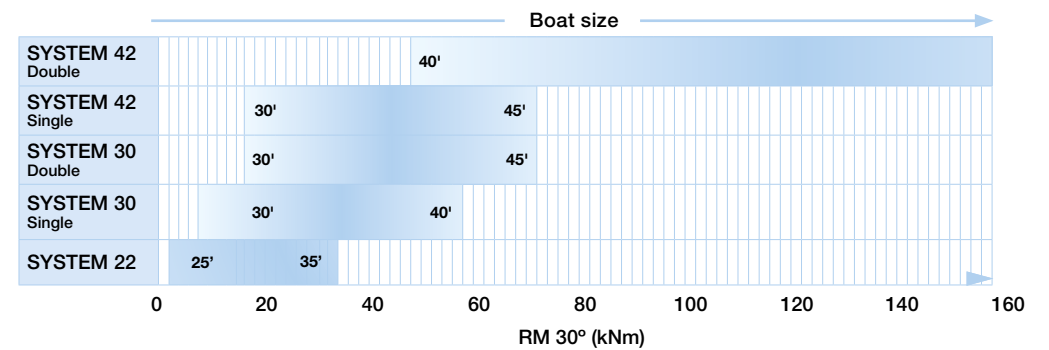

MAIN SHEET CAR, MID SHEETED BOOM (S>0,50*E)

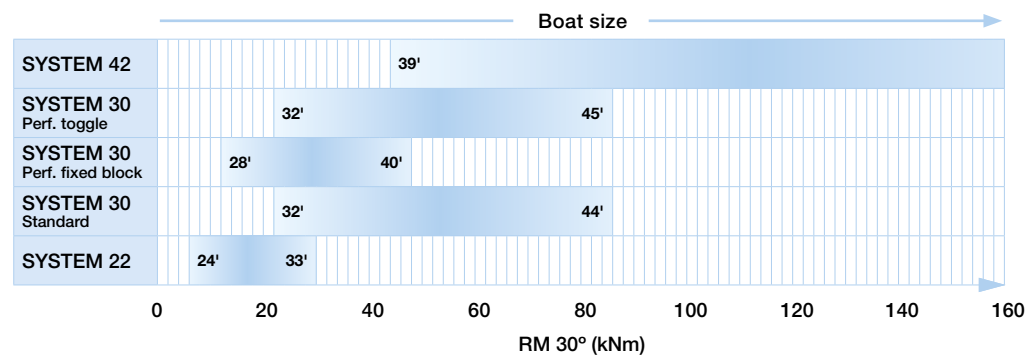

GENOA SHEET CAR

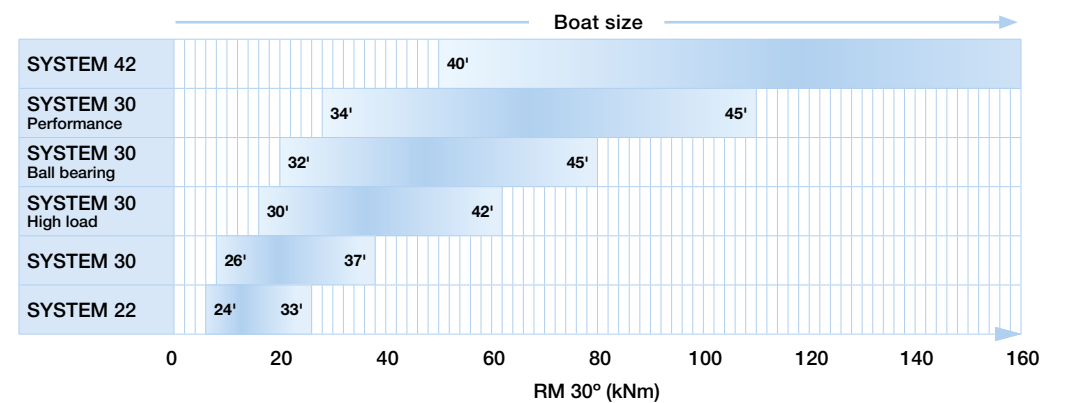

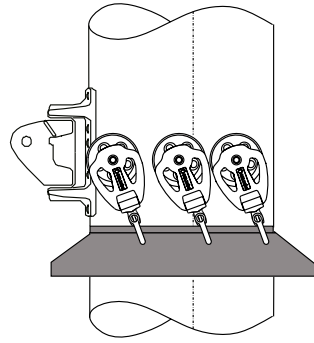

Mast base block

BLOCK FOR GENOA HALYARD, MAST BASE

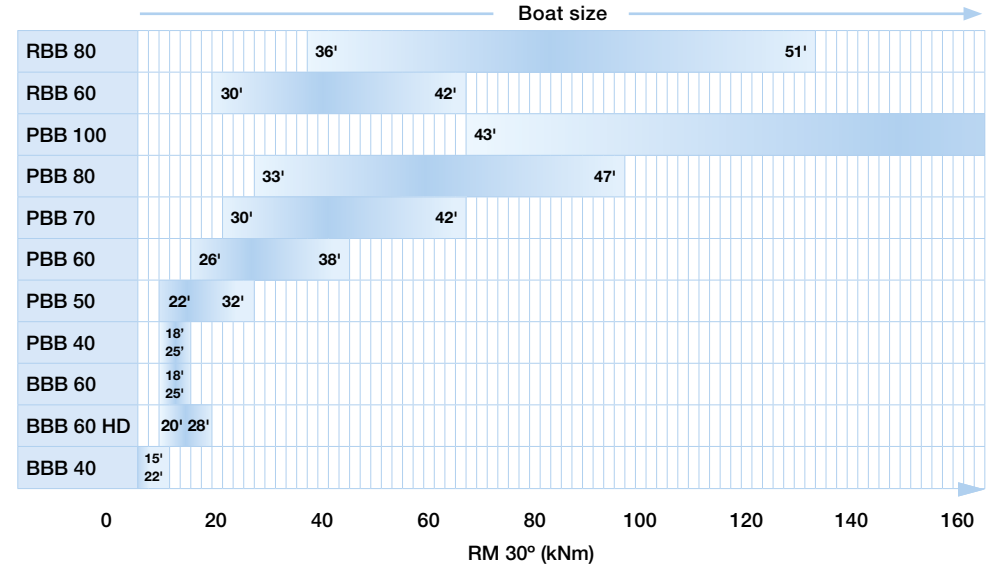

BLOCK FOR MAIN HALYARD, MAST BASE

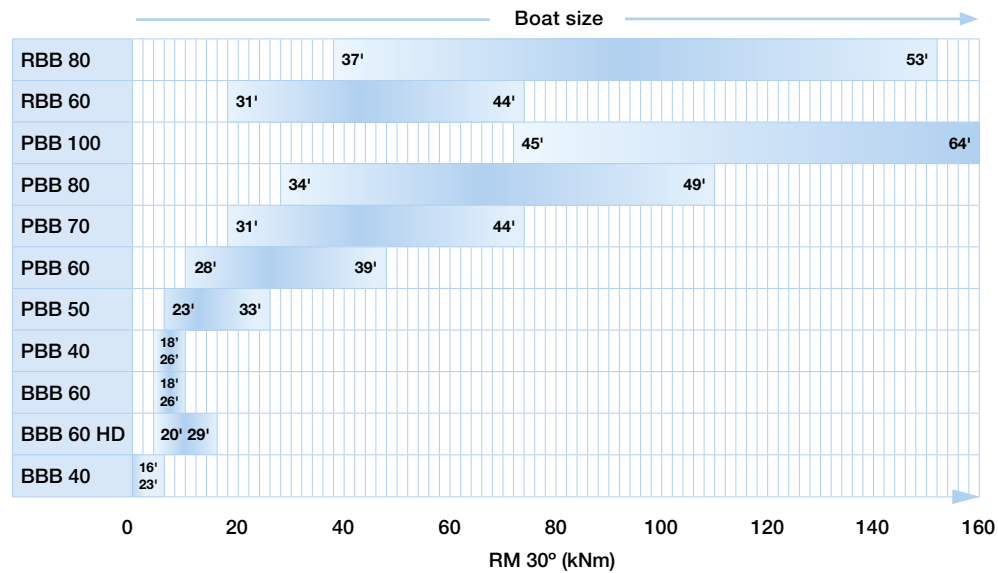

BLOCK FOR SPINNAKER HALYARD, MAST BASE

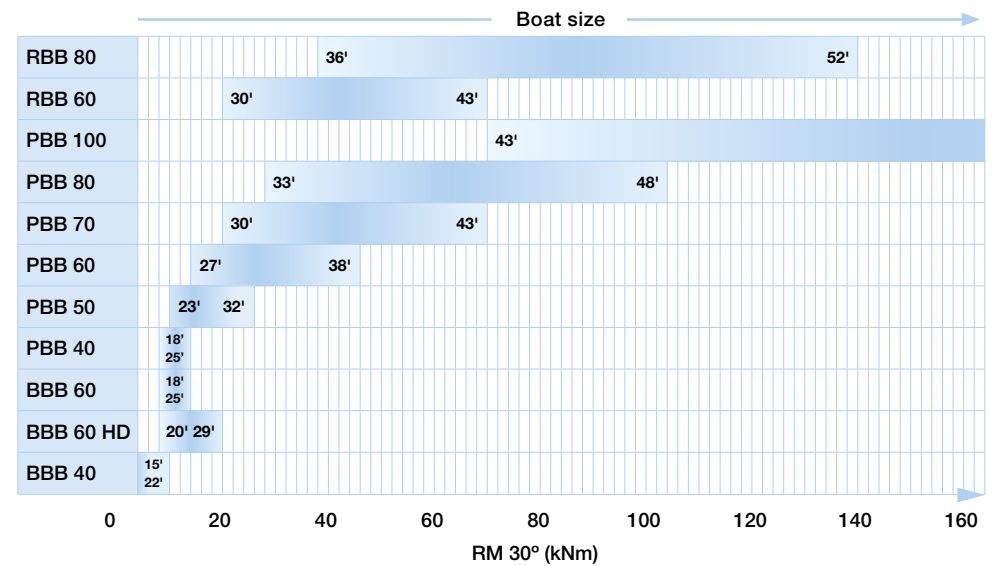

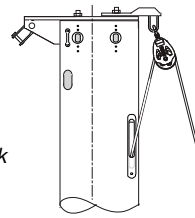

Topmast block

BLOCK FOR SPINNAKER HALYARD, TOPMAST

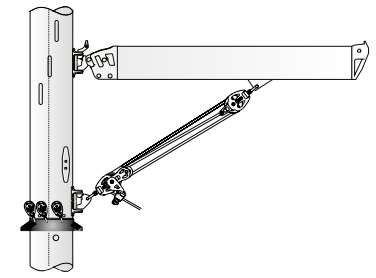
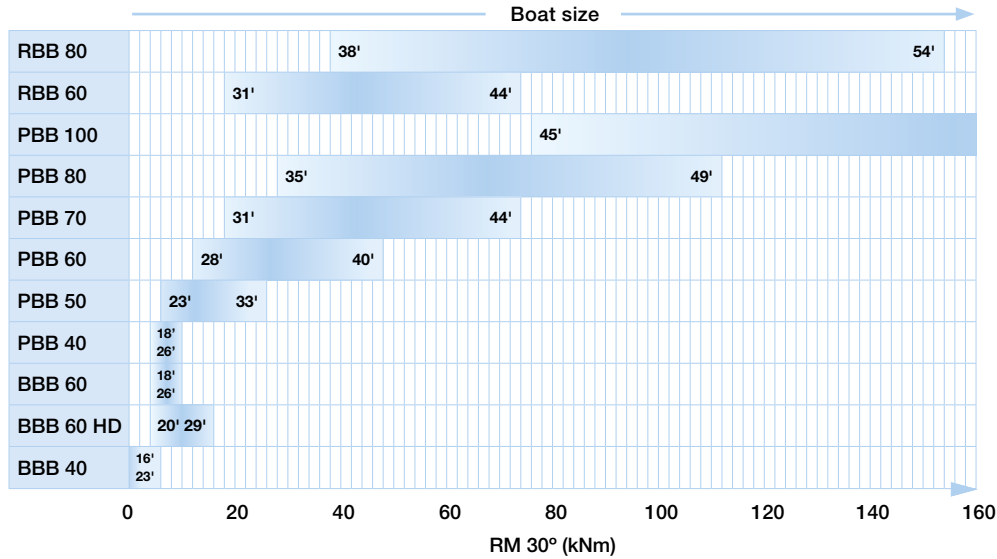

BLOCK FOR KICKING STRAP

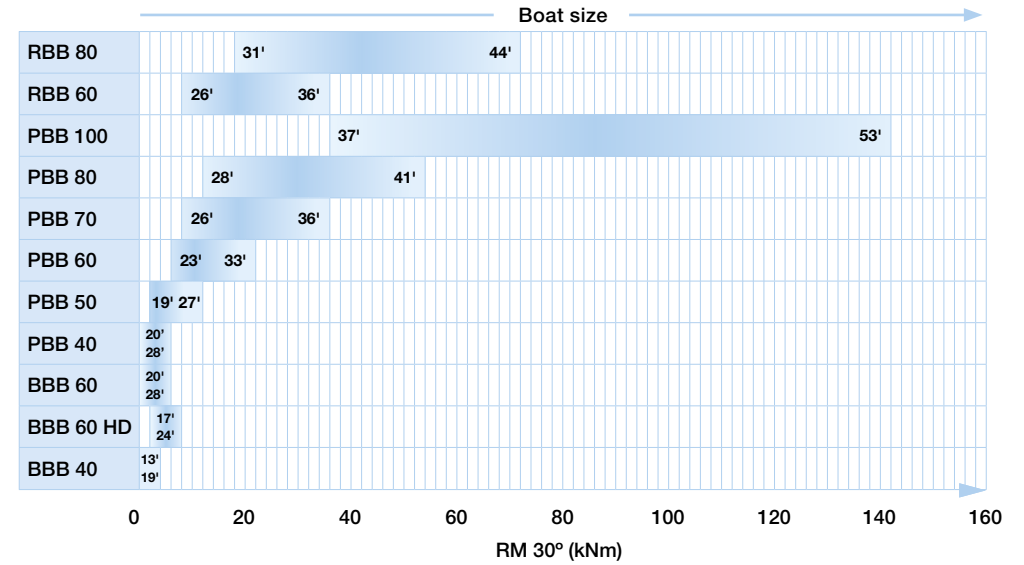

BLOCK FOR SPINNAKER SHEET AND GUY Line will turn 180 degrees

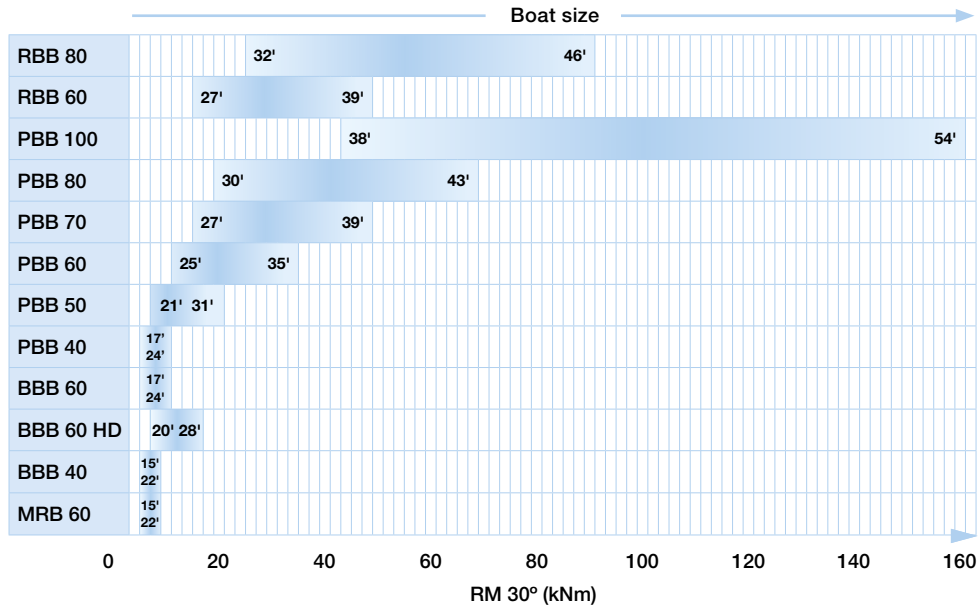

BLOCK FOR RODKICKER TACKLE

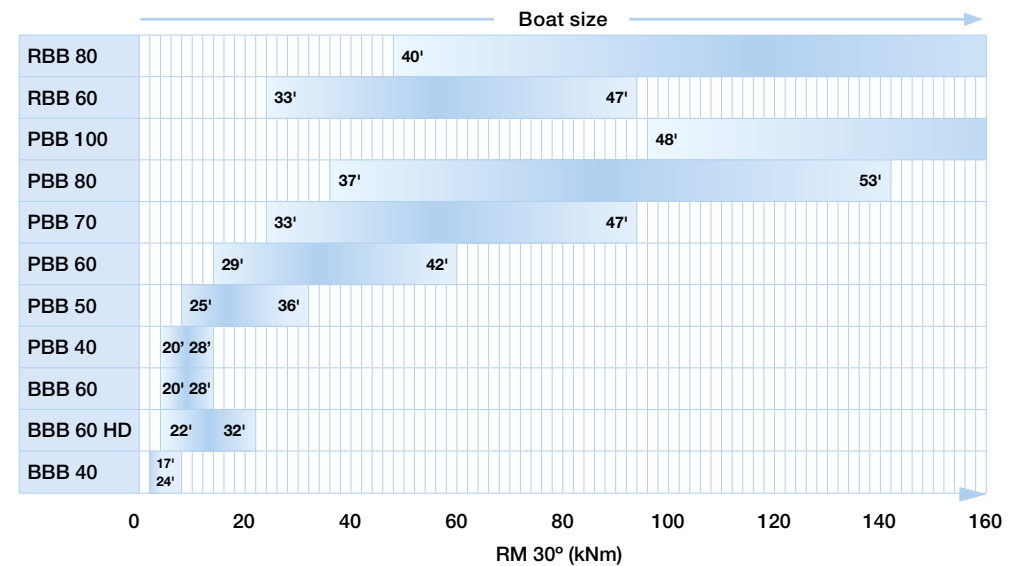

UNSUPPORTED TRACKS

An unsupported high beam track will withstand the main sheet load if correctly dimensioned.

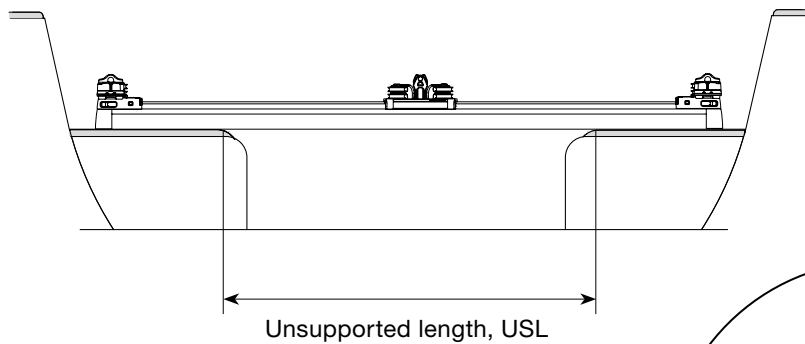

It is critical an unsupported track is mounted and secured using a minimum of three fixing bolts on either side of the unsupported length.

For further fastening information refer to the table on page 55.

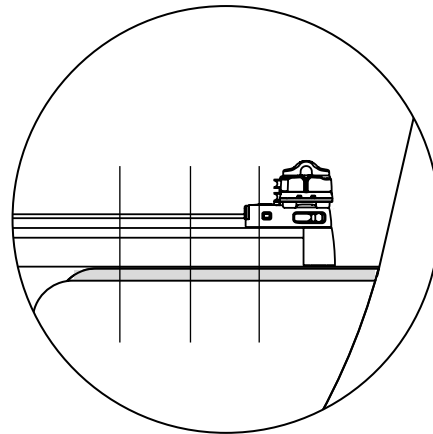

MAX UNSUPPORTED LENGTH, USL

RM 30° kNm	HB 22 USL (mm)		HB 30 USL (mm)		HB 42 USL (mm)	
	S=E	S=0.5xE	S=E	S=0.5xE	S=E	S=0.5xE
5	866	800	1792	1540		
10	800	500	1655	1310		
15	727	375	1505	1195		
20	613	305	1408	1120		
30	462	235	1281	1016		
40	378		1197	882		
50	323		1137	755		
60	284		1089	664		
70	255		1051	600		
80	232		1019	550		
90			991	500	1495	1187
100			929	465	1459	1158
110			869	435	1427	1112
120			818	410	1398	1046
130			773	390	1372	989
140			734	365	1349	939
150			700	350	1327	895
160					1307	855
170					1289	820
180					1272	788
190					1256	758
200					1241	732
210					1227	707
220					1214	684
230					1201	663
240					1189	644
250					1178	626
260					1167	609
270					1157	593
280					1147	578
290					1128	564
300					1102	551

E = foot length of the main sail. S = distance from aft side of the mast to the sheet attachment.

HOLE PATTERN

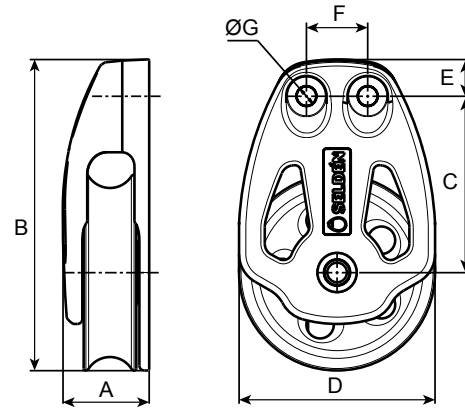

CHEEK BLOCK

Art. No.	A ¹⁾	B	C	D	E	F	ØG	Fasteners
402-101-13R	14	35	20	20	5	-	4.2	2xM4
403-101-09R	18	53	30	30	8	-	4.2	2xM4
404-101-17R	22	66	38	40	8	-	5.5	2xM5
406-301-05/-06	26	83	57	60	7.5	18	5.5	3xM5
406-601-15/-65	24	91	57	60	14	18	5.5	3xM5
405-001-15/-16/-17R	25	79	45	50	9	15	5.2	1xM5 ²⁾ 2xM5
406-001-15 ³⁾ /-16 ³⁾ /-17 ³⁾ /-18/-19/-20 ¹⁾ /-21/-22 ¹⁾ R	30	95	54	60	11	19	6.2	3xM6 ²⁾
408-001-15 ⁴⁾ /-18/-19/-20 ¹⁾ /-21/-22 ¹⁾ R	35	127	72	80	15	25	8.2	3xM8 ²⁾
410-001-15R	39	148	78	100	20	30	10.5	3xM10 ²⁾
406-201-10R	24	88	49	60	11	19	8,2	3xM8 ²⁾
406-201-11R	24	109	49	60	11	19	8,2	3xM8 ²⁾
408-201-07R	28	114	72	80	11	25	8.5	3xM8 ²⁾

¹⁾ 406-001-20/-22R A=54, 408-001-20/-22R A=67. ²⁾ Countersunk
³⁾ 1xM6 countersunk, 2xM6 ⁴⁾ 1xM8 countersunk, 2xM8

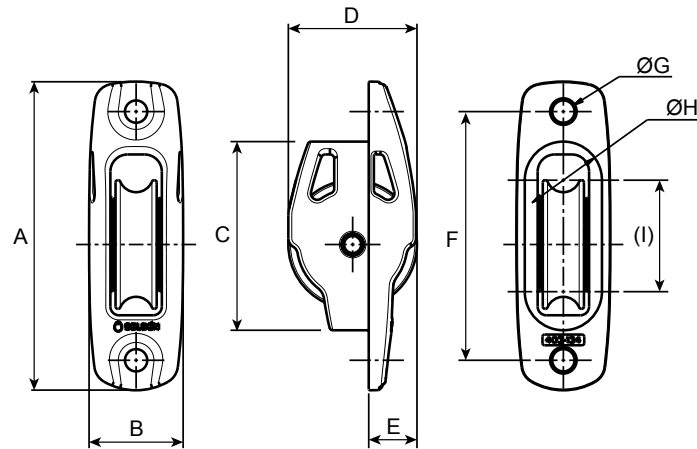

THROUGH DECK

Art. No.	A	B	C	D	E	F	ØG	ØH	I ¹⁾	Fasteners
402-101-17R	55	18	22	20	7	43.5	4.2	15	17	2xM4 ²⁾
402-101-18R	75.5	18	51.5	20	7	63.5	4.2	15	36.5	2xM4 ²⁾
403-101-22R	72	22	44	30	11	58	5.2	18	26	2xM5
403-101-24R	103	22	75	30	11	90	5.2	18	57	2xM5
404-101-22R	95	26	59	40	15	79	5.2	20	39	2xM5
404-101-24R	137	26	100	40	15	121	5.2	20	80	2xM5

¹⁾ C-C of ØH. ²⁾ Countersunk

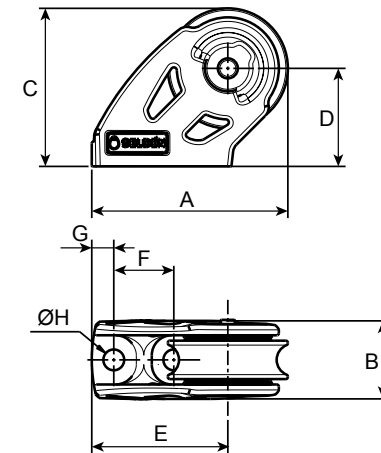

SINGLE LEAD

Art. No.	A	B	C	D	E	F	G	ØH	Fasteners
402-101-16R	37.5	15	26	17.5	29	12	6	4.2	2xM4
403-101-23R	47	19.5	37.5	24.5	34	15	5.5	5.2	2xM5
404-101-23R	62	23.5	47	30	45	20	7	5.2	2xM5

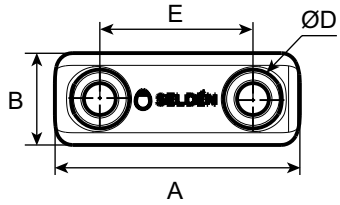
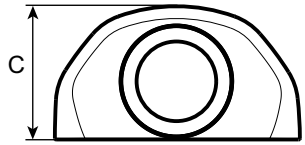

FAIRLEAD

Art. No.	A	B	C	ØD	E
508-600	25	10	11	3.6	15
508-601	38	15	17	5.1	23
508-603	25	10	14	3.6	15
508-604	40	15	22	5.1	25
508-605	52	20	30	6.5	34
508-609	25	10	8	3.6	15
508-610	25	10	11	3.6	15
508-611	38	15	17	5.1	23

SHEET LEAD

Art. No.	A	B	C	ØD	E
442-136	50	15	24	6	35
443-136	60	20	35	8	40

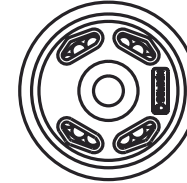
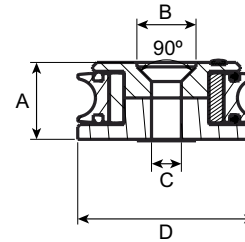

WINCH FEEDER

Art. No.	A	B	ØC	ØD	Fasteners
406-201-08	26	20	10.1	60	1xM10

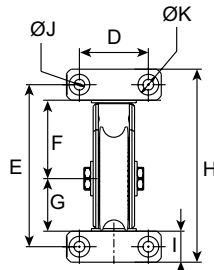
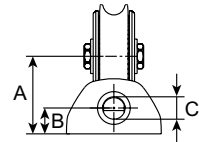

FLIP FLOP

Art. No.	A	B	C	D	E	F	G	H	I	ØJ	ØK	Fasteners
406-201-09	45	15	13	40	94	45.5	30.5	112	18	6.2	12	4xM6

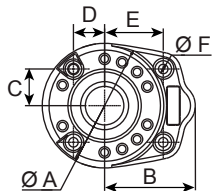
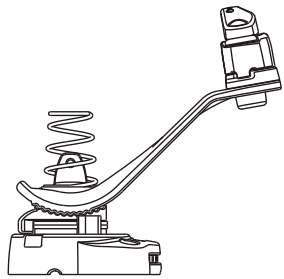

DECK SWIVEL

Art. No.	ØA	B	C	D	E	ØF	Fasteners
433-401-01R	68	50	20	17	32	5.2	4xM5

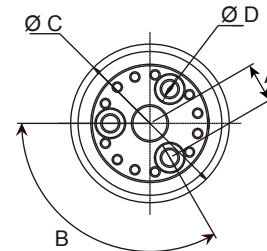
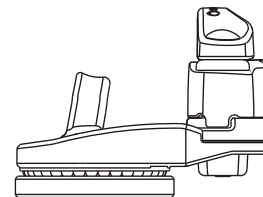

EYE SWIVEL

Art. No.	A	B	ØC	ØD	Fasteners
433-611-01/-02R	13	120°	52	5.3	3xM5

DECK ORGANIZERS

System	ØA	B	C	ØD	E	F	G	H	I	J	K
40	7	42	47	40	109	156	203	250	297	25	50
50	9	54	58	50	137	195	253	311	369	27	54

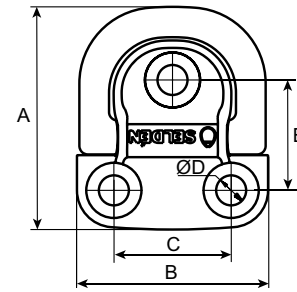
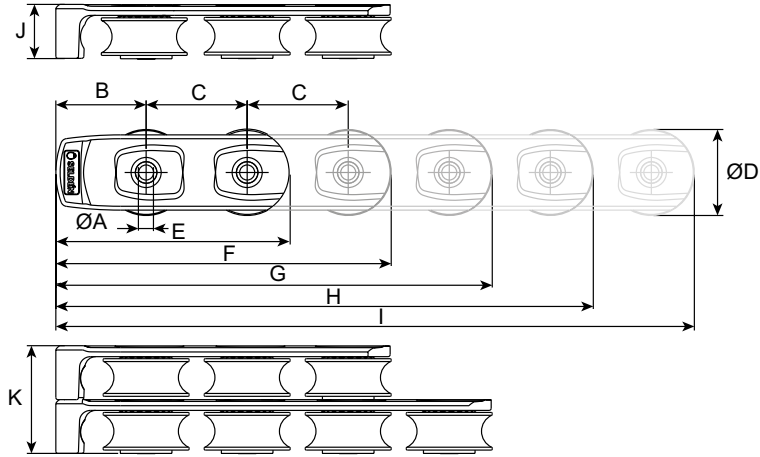

FOLDABLE PAD EYES

Art. No.	A	B	C	ØD	ØE	Fasteners ²⁾
508-750-01R	49	43	27.5	7	24	3xM6
508-760-01R	65	56	34	8.7	32	3xM8

²⁾ Countersunk

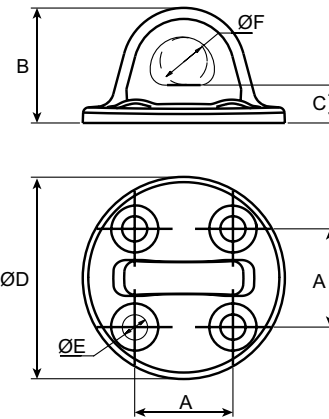

FIXED PAD EYES

Art. No.	A	B	C	ØD	ØE	ØF	Fasteners ²⁾
508-347R ¹⁾	20x25	25	6	35x40	5.2	13	4xM5
508-815R	30	26	8.5	50	6.5	11	2xM6
508-816R	30	34	11	60	6.5	14	4xM6
508-817R	35	41	13.5	72	9	16.5	4xM8
508-818R	42	52	17.5	86	11	20.5	4xM10

¹⁾ Squared base, see page 88. ²⁾ Countersunk

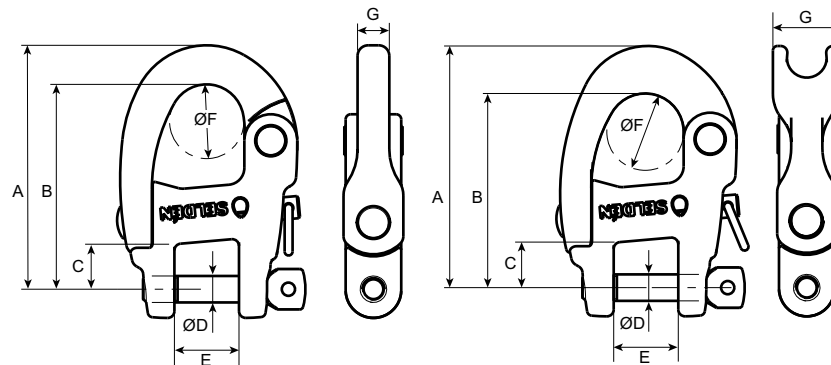

SNAP SHACKLE ADAPTOR/ LOW FRICTION SHACKLE

Art. No.	A	B	C	ØD	E	ØF	G
307-435-01	45.6	36.7	8.6	5	12.2	14.5	12.8
307-436-01	53.9	42.8	9.5	6	13.2	17.3	15.2
307-437-01	72	56.7	12.7	10	18.2	23.1	20.2
307-438-01	89	70	9.6	12	22.5	28.6	25
404-040-01	32.5	27	5.8	4	8.2	10	4.6
405-040-01	46.1	38.7	8.5	5	12.2	14	6
406-040-01	54	45.5	9.4	6	13.2	16.5	6.8
408-040-01	71.7	60.7	12.5	10	18.2	22	9.3
410-040-01	88.6	75	15.5	12	22.5	27.2	11.6

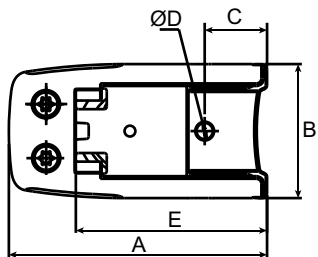

END CONTROL

Art. No.	A	B	C	ØD	E	Fasteners
442-112-01/-02/-03/-04	87	40	23	5.2	53	1xM5
443-112-01/-02/-03/-04	107	52	31	6.2	81	1xM6 ¹⁾
444-112-01/-02/-03/-04	138	70	48	10.2	91	1xM10 ¹⁾
444-148-01/-02	144	70	48	10.2	137	2xM10 ¹⁾

¹⁾ Countersunk

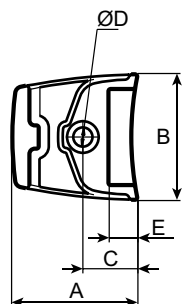
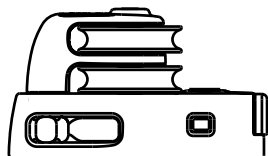

END CAP

Art. No.	A	B	C	ØD	E	Fasteners ¹⁾
441-105	27	24	16	5.2	4	1xM5
442-105	36	33	14	5.2	8	1xM5
443-125	41	41	18	6.2	9	1xM6
444-127	44	51	30	10.2	13	1xM10

¹⁾ Countersunk

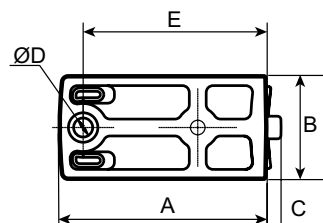
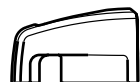

END CONTROL GENOA

Art. No.	A	B	C	ØD	E	Fasteners ¹⁾
442-103-01	60	30	4	5,5	53	1xM5
443-124-01	71	45	10	6,2	62	1xM6

¹⁾ Countersunk

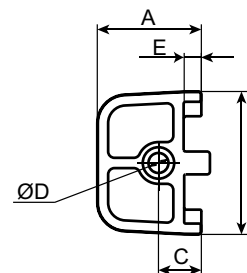
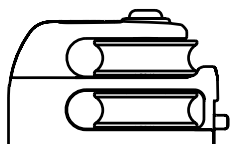

HIGH BEAM ADAPTOR

Art. No.	A	B	C	ØD	E
442-135	40	37	30	5.2	20
443-135	36	50	15	7.2	6
444-135	64	70	41	10.2	25

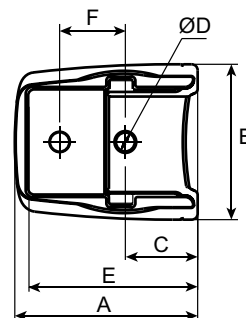
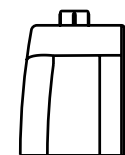

END STOP

Art. No.	A	B	C	ØD	E	F	Fasteners
442-138-01	51	40	23	5.2	45	18	2xM5
443-142-01	70	52	22	6.2	65	22	2xM6 ¹⁾
443-166-01	72	51	29	8.2	67	22	2xM8 ¹⁾
444-138-01	90	70	43	10.2	57	30	2xM10 ¹⁾
444-143-01	48	70	70,5	10.2	95	29	2xM10 ¹⁾

¹⁾ Countersunk

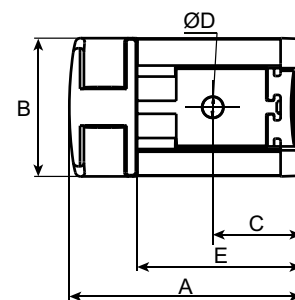

END CONTROL PERFORMANCE

Art. No.	A	B	C	ØD	E
443-303-01/-02	89	53	34	8,2	63
443-304-02/-03	124	53	69	8,2	98

Fasteners included. M8 screw to be threaded in the track.

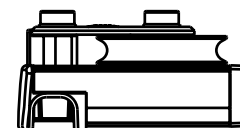

CONTENTS IN ALPHABETICAL ORDER

A		H		S	
Applications	6	Halyard shackle	96	Sealing washer	54
B		Hatches	97	Self tacking systems	78
Ball bearing block 20	34	Hole patterns	107	Shackles	96
Ball bearing block 30	36	K		Sheet lead	94
Ball bearing block 40	38	Keel band	97	Sheet crane	79
Ball bearing block 60	40	L		Sheet exit box	79
Ball bearing block High load 25	46	Loads	6, 100	Sheet systems	82
Block for 2:1 purchase	95	Low friction rings	99	Shroud adjusters	97
C		Lubrication	31	Soft shackles	96
Cam cleats	86	M		Stand-up springs	98
Cars, see traveller systems		Main systems	72	Swivel locks	94
Cascade	6, 33, 100	Mast swivel	91	T	
Chafe guards	97	P		Tackles	83
Clam cleats	88	Padeyes	98	Tiller extensions	97
Complete sheet systems	82	Plain bearing block 16	14	Track system 22, 30, 42	54
D		Plain bearing block 20	14	Traveller system 15	52
Deck organizers	92	Plain bearing block 40	15	Traveller system 22	60
Deck swivel	91	Plain bearing block 50	16	Traveller system 30	62
Dead end	97	Plain bearing block 60	18	Traveller system 30 Performance	66
Dinghy accessories	97	Plain bearing block 60 Quick lock	26	Traveller system 42	70
Dimensioning	102	Plain bearing block 70	20	Tilt-absorber	76
Double fairlead	99	Plain bearing block 80	22	Toe strap fitting	97
Double snap lead shackle	96	Plain bearing block 80 Quick lock	26	U	
E		Plain bearing block 100	24	U-bolt	97
Eye bolt	98	Plain bearing block High load	48	Unsupported tracks	106
Eye swivel	90	R		V	
F		Ratchet block ARB 45	43	Valley cleats	88
Fairlead	94	Ratchet block MRB 60	44	W	
Flip flop	14, 30	Roller bearing block 60	30	Webbing bridge	97
G		Roller bearing block 80	31	Wire breaking load	100
Genoa systems	76				

DINGHIESKEELBOATSYACHTS

Seldén Mast AB, Sweden

Tel +46 (0)31 69 69 00

Fax +46 (0)31 29 71 37

e-mail info@seldenmast.com

Seldén Mast Limited, UK

Tel +44 (0)1329 50 40 00

Fax +44 (0)1329 50 40 49

e-mail info@seldenmast.co.uk

Seldén Mast Inc., USA

Tel +1 843-760-6278

Fax +1 843-760-1220

e-mail info@seldenus.com

Seldén Mast A/S, Denmark

Tel +45 39 18 44 00

Fax +45 39 27 17 00

e-mail info@seldenmast.dk

**Seldén Mid Europe B.V.,
Netherlands**

Tel +31 (0)111-698 120

Fax +31 (0)111-698 130

e-mail info@seldenmast.nl

Seldén Mast SAS, France

Tel +33 (0)251 362 110

Fax +33 (0)251 362 185

e-mail info@seldenmast.fr

**Seldén Mast Asia Ltd,
Hong Kong**

Tel +852 3572 0613

Fax +852 3572 0623

e-mail info@seldenmast.com.hk

www.seldenmast.com

The Seldén Group is the world's leading manufacturer of mast and rigging systems in carbon and aluminium for dinghies, keelboats and yachts.

Our well known brands are Seldén and Furlex.

The worldwide success of Furlex has enabled us to build a network of over 750 authorised dealers covering the world's marine markets. So wherever you sail, you can be sure of fast access to our service, spare parts and know-how.

Seldén and Furlex are registered trademarks of Seldén Mast AB.